

---

## CubePro User Guide



## CubePro<sup>®</sup> User Guide

### Introduction

Thank you for purchasing the CubePro™ 3D engineering and prosumer printer. This printer allows you to express your creativity like never before. With many different material colors to choose from, enjoy the freedom to print in color or mix it up.

With its ready-to-print technology, the CubePro provides a new dimension to your imagination.

### Copyright

©2016 by 3D Systems, Inc. All rights reserved. This document is subject to change without notice. This document is copyrighted and contains proprietary information that is the property of 3D Systems, Inc. The 3D Systems logo is a registered trademark of 3D Systems, Inc. CubePro is a trademark of 3D Systems, Inc. Use of the [3DSystems.com](http://3DSystems.com) website constitutes acceptance of its Terms of Service and Privacy Policy.

### Compliance

#### FCC Notice

This equipment has been tested and found to comply with the limits for a Class B digital device, pursuant to part 15 of the FCC Rules. These limits are designed to provide reasonable protection against harmful interference in a residential installation. This equipment generates, uses and can radiate radio frequency energy and, if not installed and used in accordance with the instructions, may cause harmful interference to radio communications. However, there is no guarantee that interference will not occur in a particular installation. If this equipment does cause harmful interference to radio or television reception, which can be determined by turning the equipment off and on, the user is encouraged to try to correct the interference by one or more of the following measures:

- Reorient or relocate the receiving antenna.
- Increase the separation between the equipment and receiver.
- Connect the equipment into an outlet on a circuit different from that to which the receiver is connected.
- Consult the dealer or an experienced radio/TV technician for help.



**NOTE:** Changes or modifications to this equipment not specifically approved by 3D Systems may void the user's authority to operate this equipment.

### KCC

이 기기는 가정용 (Class B) 전자파 적합성 기기입니다. 이 기기를 사용할 때는 라디오 수신기와의 거리를 충분히 유지하고 배선 가이드라인을 따르십시오.

This equipment is home use (Class B) electromagnetic wave suitability equipment and to be used mainly at home and it can be used in all areas.

---

This equipment conforms with International Electric Committee (IEC) 60950-1 and meets the requirements of the applicable EC directives.

---

## CAN ICES-3 (B)/NMB-3(B)

---

This device complies with Industry Canada license-exempt RSS standard(s). Operation is subject to the following two conditions: (1) this device may not cause interference, and (2) this device must accept any interference, including interference that may cause undesired operation of the device.

Le présent appareil est conforme aux CNR d'Industrie Canada applicables aux appareils radio exempts de licence. L'exploitation est autorisée aux deux conditions suivantes: (1) l'appareil ne doit pas produire de brouillage, et (2) l'utilisateur de l'appareil doit accepter tout brouillage radioélectrique subi, même si le brouillage est susceptible d'en compromettre le fonctionnement.

---

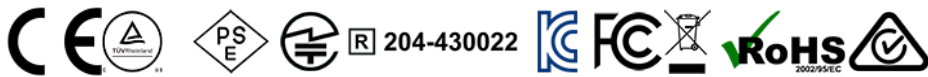

### Warranty

3D Systems warrants that the CubePro 3D Printer will be free from defects in materials and workmanship, during the applicable warranty period, when used under the normal conditions described in the documentation provided to you, including this User Guide. 3D Systems will promptly repair or replace the CubePro 3D Printer, if required, to make it free of defects during the warranty period. This warranty excludes (i) normal consumable or expendable parts (such as Material Cartridges), (ii) repairs required during the warranty period because of abnormal use or conditions (such as riots, floods, misuse, neglect or improper service by anyone except 3D Systems or its authorized service provider), and (iii) repairs required during the warranty period because of the use of non-integrated, nonapproved or non-licensed materials with the CubePro 3D Printer. The warranty period for the CubePro 3D printer is the shorter of (i) 90 days from the date your CubePro 3D printer is activated or (ii) 24 months after the CubePro 3D Printer is shipped from 3D Systems to the end customer or intermediary. For consumers who are covered by consumer protection laws or regulations in their country of purchase or, if different, their country of residence, the benefits conferred by our ninety (90) day warranty are in addition to, and operate concurrently with, all rights and remedies conveyed by such consumer protection laws and regulations, including but not limited to these additional rights.

THIS WARRANTY IS THE ONLY WARRANTY PROVIDED FOR THE CUBEPRO 3D PRINTER. TO THE MAXIMUM EXTENT PERMITTED BY LAW, 3D SYSTEMS EXPRESSLY DISCLAIMS ALL OTHER WARRANTIES FOR THE CUBEPRO 3D PRINTER AND EACH OF ITS COMPONENTS, WHETHER THOSE WARRANTIES ARE EXPRESS, IMPLIED OR STATUTORY, INCLUDING WARRANTIES OF MERCHANTABILITY AND FITNESS FOR INTENDED OR PARTICULAR PURPOSES.

#### Limitation of Liability

3D SYSTEMS WILL NOT BE RESPONSIBLE FOR INDIRECT, SPECIAL, CONSEQUENTIAL, EXEMPLARY OR INCIDENTAL DAMAGES (SUCH AS LOSS OF PROFIT OR EMPLOYEE'S TIME) REGARDLESS OF THE REASON. IN NO EVENT SHALL THE LIABILITY AND/OR OBLIGATIONS OF 3D SYSTEMS ARISING OUT OF THE PURCHASE, LEASE, LICENSE AND/OR USE OF THE EQUIPMENT BY YOU OR OTHERS EXCEED THE PURCHASE PRICE OF THE CUBEPRO 3D PRINTER.

---

### Warranty Hotline from the Americas

**888-598-1440** inside the US and **+1 678-338-3480** outside the US weekdays during normal business hours or by email at [cubifysupport@cubeify.com](mailto:cubifysupport@cubeify.com).

---

### Warranty Hotline from Europe

**+44 1442 279 839** (UK) or **+49 6151 357 499** (DE) weekdays during normal business hours or by email at [cubifysupport@cubeify.com](mailto:cubifysupport@cubeify.com).

## Important Safety Information

### Safety Symbols and Definitions



**HOT SURFACE HAZARD: A HOT SURFACE IS ACCESSIBLE IN THE VICINITY OF THIS SIGN OR AT THE PRINT JET. AVOID CONTACT WITH THESE AREAS. HOT SURFACES CAN CAUSE SEVERE BURNS.**



Caution: Indicates something may happen that could cause loss of data, damage to equipment, or could cause personal injury.



Caution: Indicates a pinch point hazard that could cause personal injury.



**SHOCK WARNING: INDICATES A POTENTIAL SHOCK HAZARD.**

### SAFETY GUIDELINES

- Follow all safety rules in this section and observe all cautions and warnings in this guide.
- Do not modify any safety features or make modifications to the CubePro. Doing so is prohibited and voids the warranty.
- Use of print materials other than genuine 3D Systems components may void the warranty.



**WARNING: HAZARDOUS MOVING PARTS. KEEP FINGERS AND OTHER BODY PARTS AWAY.**



**HOT SURFACE HAZARD: DO NOT TOUCH THE PRINT JETS DURING SETUP AND OPERATION. THE PRINT JETS BECOME VERY HOT.**



Caution: Read and follow all instruction prior to setting up the printer.



**SHOCK WARNING: DUE TO RISK OF SHOCK, AVOID CONTACT WITH ALL INTERNAL ELECTRONIC COMPONENTS.**



**WARNING: THE CUBEPRO SHOULD ONLY BE SERVICED BY AUTHORIZED SERVICE TECHNICIANS. PRIOR TO ANY PART REPLACEMENT PROCEDURE, THE PRINTER MUST BE POWERED OFF AND DISCONNECTED FROM UTILITY POWER.**



**HOT SURFACE HAZARD: WHEN PRINTING WITH ABS MATERIAL, THE INTERIOR (PRINT CHAMBER) OF THE PRINTER WILL HEAT TO A PREDETERMINED TEMPERATURE. THE SURFACE OF THE PRINT CHAMBER HEATER WILL BE HOT. AVOID CONTACT WITH THE PRINT CHAMBER HEATER AND NOTE THAT OTHER COMPONENTS INSIDE THE PRINT CHAMBER MAY BE HOT.**

To ensure safety, please exercise caution when operating your CubePro. Read and follow all safety precautions as outlined in this user guide. Be careful when operating your CubePro to ensure proper printing and be mindful of and avoid hot surfaces.

## Features And Benefits

The CubePro 3D printer prints the model by pulling material from the cartridge through the print jets via the delivery tubes. The material is then jetted through the print jet in a thin string of molten material. The print jet movement is coordinated by the print plate, which lowers incrementally after each layer is deposited so a new layer can be drawn on top of the last, building the part up.

### CubePro 3D Printer Properties

- Plastic Jet Printing (PJP) technology
- Houses up to three print jets for multi-color and multi-material prints
- Choice between ABS and PLA plastic, both recyclable
- Prints objects up to 275 x 265 x 230 mm (10.75"x10.5"x9.05")
- Smart Insta Load print cartridge
- Fully automated supports: peel off supports for ABS and PLA. PLA supports can also be removed using an Ultrasonic Support Removal Tank available at <http://3dsystems.com/shop/cubepro/supplies>.

### Print Materials

By default, the CubePro can print PLA and ABS print material. Each material has unique benefits and you can guide your selection based on the properties your part requires.

- This is a hard plastic that has a low environmental impact. It is derived from renewable, starch-based resources.
  - We recommend using PLA when printing extra-large parts on CubePro as it is a more stable print material.
- PLA**
- PLA is the optimal support material for industrial ABS parts. PLA has the ability to dissolve away in caustic soda solutions supported by an ultra-sonic tank.
  - This is a well-known plastic known for its strength and industrial properties.
- ABS**
- As a build material, ABS is good for both small and large parts.
  - ABS works well as a support material for extra-large PLA parts.
  - Infinity Rinse-Away is a water soluble material that allows you to print your part with rinse-away supports.
- INF**
- Compatible with PLA and nylon.
  - Print complex parts with intricate patterns and suspension in space.
  - Nylon is a strong, flexible and durable material that prints detailed parts.
- NYL**
- Excellent material for prototyping, small-run manufacturing and parts requiring secondary operations.
  - INF is the optimal support material for nylon parts.

## At-A-Glance

Get acquainted with your CubePro 3D printer before beginning your first print. This section identifies the important areas that will be discussed throughout this guide.

CubePro Trio is depicted for illustration purposes only. Locations of important areas are the same for the CubePro and CubePro Duo.

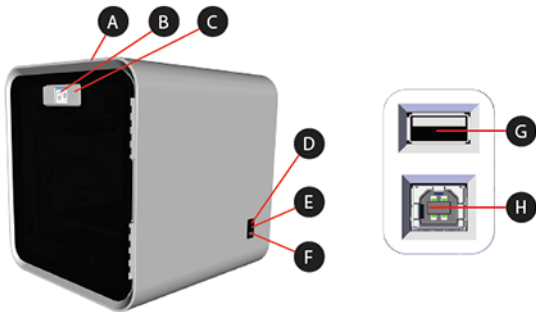

- |          |                           |          |                      |
|----------|---------------------------|----------|----------------------|
| <b>A</b> | Removable Top Cover       | <b>E</b> | Printer Power Switch |
| <b>B</b> | Touchscreen Display       | <b>F</b> | Power Inlet Port     |
| <b>C</b> | Touchscreen On/Off Button | <b>G</b> | USB Inlet Port       |
| <b>D</b> | Fuses                     | <b>H</b> | Printer USB Port     |

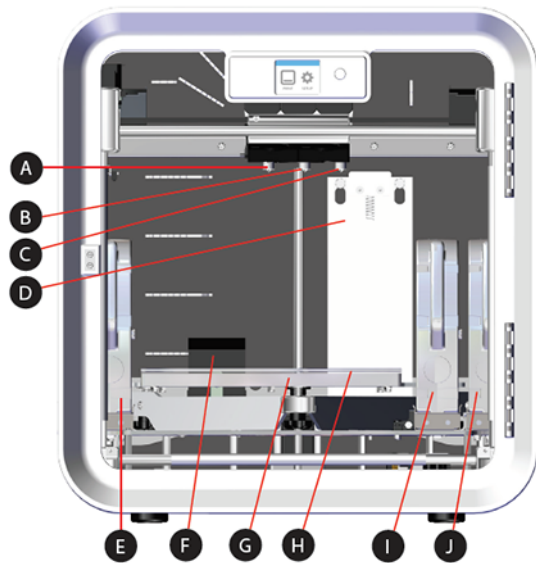

- |          |                    |          |                      |
|----------|--------------------|----------|----------------------|
| <b>A</b> | Print Jet 1        | <b>F</b> | Print Chamber Heater |
| <b>B</b> | Print Jet 2        | <b>G</b> | Print Plate          |
| <b>C</b> | Print Jet 3        | <b>H</b> | Print Pad            |
| <b>D</b> | Jet Wiper Assembly | <b>I</b> | Material Cartridge 2 |



Material Cartridge 1



Material Cartridge 3



NOTE: The following image illustrates the second and third cartridge bays of a CubePro Trio.

View From Top

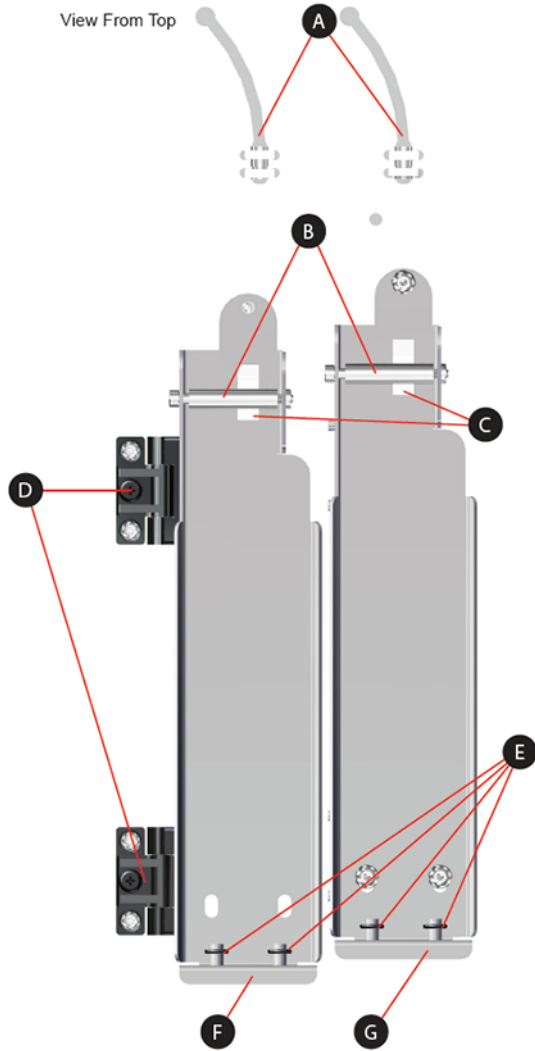

Material Tube



Material Cartridge Mount Rings



Clamp Rollers



Material Cartridge Bay 2



Cartridge Recognition Connections



Material Cartridge Bay 3



Material Cartridge Bay 2 Hinge

## Specifications And Requirements

### Dimensions And Weight

#### Dimensions

- 566.7 mm (w) x 581.0 mm (d) x 606.4 mm (h) (22 5/16" (w) x 22 7/8" (d) x 23 7/8" (h))

#### Weight Unboxed:

- 41 kg (90.7 lbs.)
- 43 kg (94.3 lbs.) Duo
- 44 kg (98 lbs.) Trio

#### Weight Boxed:

- Maximum: 58.97 kg (130 lbs.)
- Maximum: 59.87 kg (132 lbs.) Duo
- Maximum: 60.78 kg (134 lbs.) Trio

### PC Requirements

- Windows 7, 8, 8.1 and 10



- Multi-core processor - 2GHz or faster per core
- System RAM - 2GB
- Screen resolution - 1024 x 768 dpi

### Software

- CubePro Client Software - Available at <http://3dsystems.com/shop/cubepro/downloads>.

### Electrical Requirements

- 100-240V AC 50-60 Hz auto switching, 6A

### Material Storage

Although all polymers degrade with time, the following conditions help ensure the quality of the material:

- Unpack the material only as needed
- Store the material at 18-29°C (65-85°F)
- Store the material enclosed in a dry environment (low humidity)
- Use within 12 months of receipt

# Unpacking And Setting Up Your CubePro

## Contents



\*The number of cartridges depends on the ordered configuration.



NOTE: The appearance of some components may vary.

## Unpacking And Initial Setup



**CAUTION:** Due to the size and weight of the printer, this procedure may require more than one person. Ensure there are enough people to safely and comfortably move the printer to its final location.



NOTE: Ensure that you save all foam and packing material for the future repacking of your CubePro. Transporting the printer without original packing materials may damage the printer

1. Carefully cut the straps if applicable and then pull the tabs on all four release clips.



NOTE: There is one release clip on each side of the box.

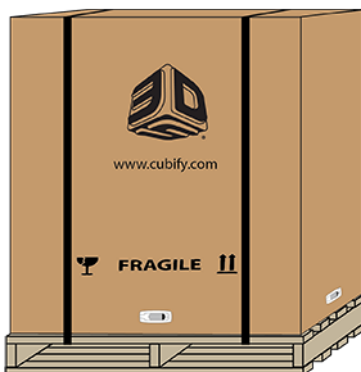

2. Pull the handles (A) and remove the release clips from the outer box.

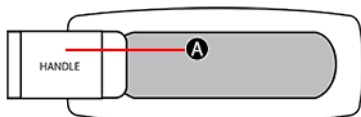

3. Lift the box away from the printer.



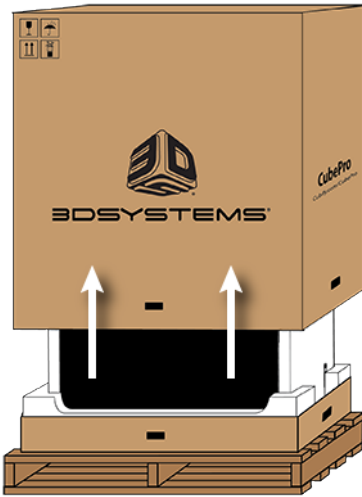

4. Remove the accessories tray (A).

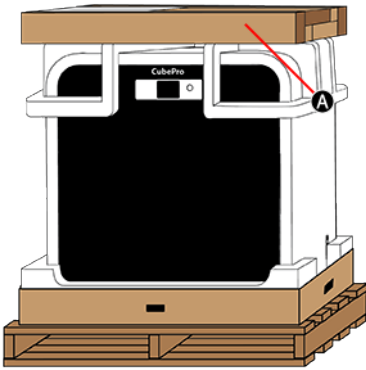

5. Remove the upper foam supports (A) from the printer.

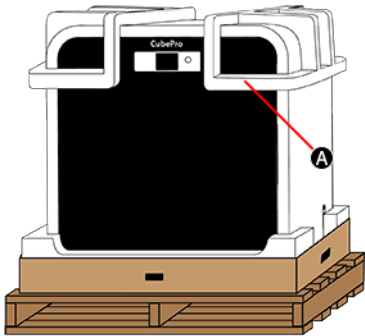

6. Pull the protective bag down around the printer and remove the printer assembly from the lower foam support.

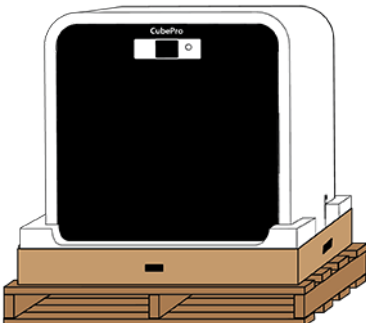

7. Position the printer where it will be used.



**NOTE:** Ensure the printer is placed in a location where its size and weight will be properly supported.

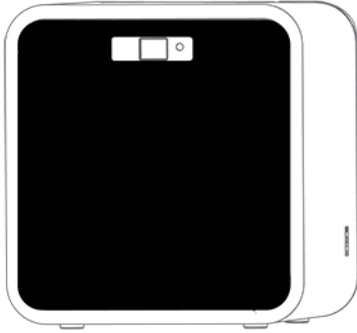

8. Unpack the top layer of the accessories tray.



**NOTE:** Depending on the printer configuration, the arrangement of the accessory boxes may differ. Unpack the power cord (A), the spacer (B), material cartridge, tool kit and Cube Glue(C). Your configuration may include 1, 2 or three cartridges. For configurations with fewer than three cartridges included, empty boxes may be used as spacers.

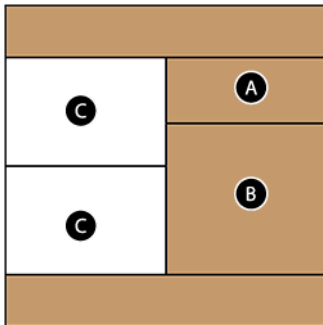

9. Unpack the bottom layer of the accessories tray.



**NOTE:** Depending on the printer configuration, the arrangement of the accessory boxes may differ. Unpack the print pad (A), the jet wiper assembly (B), and material cartridges (C). Your configuration may include 1, 2 or 3 cartridges. For configurations with fewer than three cartridges included, empty boxes may be used as spacers.



**CAUTION:** The print pad is fragile. Exercise caution when handling the print pad.

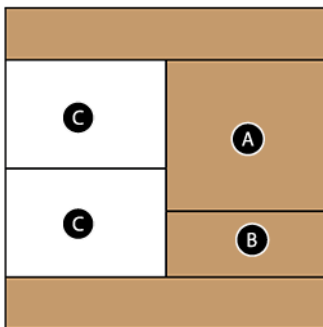

10. Open the front door. Cut away the zip ties (A) and remove the foam tubing from the print jet area.



**NOTE:** For illustration purposes only, the door was removed from the image. Do not attempt to remove the door from the printer.

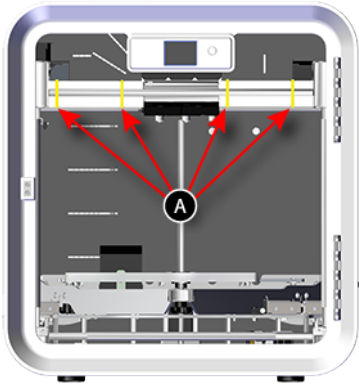

11. Loosen and remove the four (4) 4mm screws securing the Z-Axis guard and remove the guard. Save the guard and screws for future repacking.

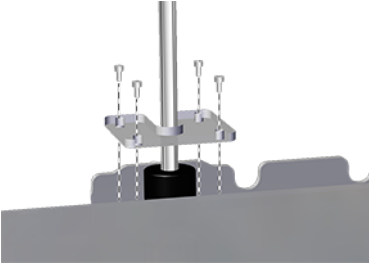

12. Using a 4mm hex head driver, attach the mounting posts to the jet wiper assembly with the supplied screws and washers.



**NOTE:** Tighten the screws until the posts are secure.



**CAUTION:** Do not over-tighten the screws. The jet wiper assembly can break if the screws are over-tightened.

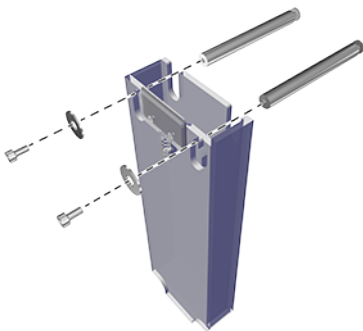

13. Move the jet wiper assembly to the back of the printer and locate the keyhole slots (A).

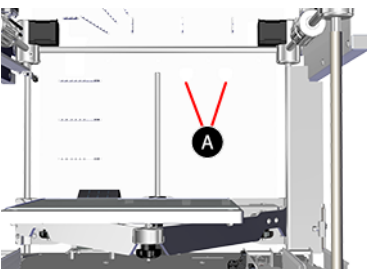

14. Mount the jet wiper mounting posts to the back panel of the printer through the keyhole slots.



**NOTE:** Slide the mounting pins downward.

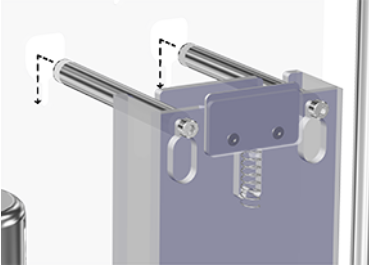

15. Align the jet wiper assembly bottom tab (A) with the slot in the floor (B) and slide the jet wiper assembly downward.



**NOTE:** If the jet wiper assembly is fully seated into the keyhole slots but the bottom does not rest on the thumbscrew head, remove the jet wiper and turn the thumbscrew counter-clockwise until the jet wiper bottom rests on the thumbscrew head and the keyhole slots are fully seated. This may require repeated removals and re-installations of the jet wiper. If the keyhole slots will not seat, the thumbscrew may need to be adjusted downward by turning clockwise.



**NOTE:** Refer to the section titled [Adjusting the Jet Wiper](#) for information about adjusting the jet wiper scraper height.

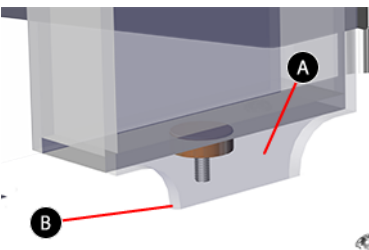

16. Remove the print pad from the box and place it onto the print platform with the round magnet on the bottom of the pad inserted into the triangular opening on the platform. Ensure the print pad is securely seated on the print plate.

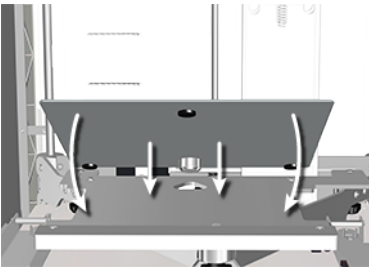

17. Connect the power cord to the power inlet port (B) on the right side of the printer and the other end to a wall outlet. Press the power on/off switch (A) to power on the CubePro.

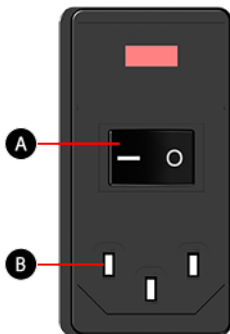

18. Press the on/off button (A) beside the LED screen to power on the CubePro touchscreen display.



19. Press the touchscreen to navigate to the main menu.



**NOTE:** Turning on the touchscreen will also turn on the interior LED lights.

## Setup And Activation

1. Select your language. Press the checkmark to confirm your selection.

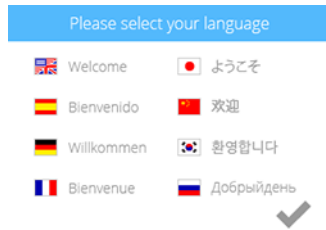

2. Enter a name for your printer. Scroll to the letters you wish to select by pressing the arrow symbols on each side of the screen. Press the letters to select them. Select the checkmark to continue. If you do not wish to name your CubePro, press SKIP to move to the next screen and continue with step 4.

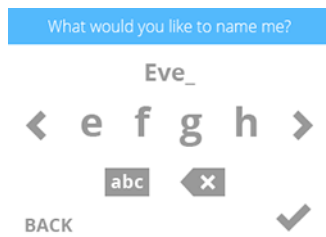

NOTE: The printer will search for area wireless networks.

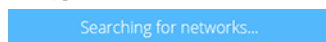

CANCEL

SKIP

3. Connect your printer to your wireless network. Use the up or down arrow to scroll to your network choice. Select your network.



NOTE: If your network is password protected, the printer will first prompt you to enter the password.



NOTE: The printer can also connect to an ad hoc network, a decentralized network that wirelessly connects a local computer to the printer directly. The computer must have a wireless adapter configured for ad-hoc mode. The adapter must use the same SSID as is found in the printer. Connecting to an ad hoc network is discussed further in the section titled [Setting Up an Ad Hoc Network](#).

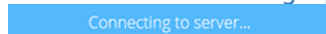

NOTE: Connection to a network is confirmed when a checkmark appears to the left of the network name. If the network is secured, a lock icon will appear to the right of the network name.

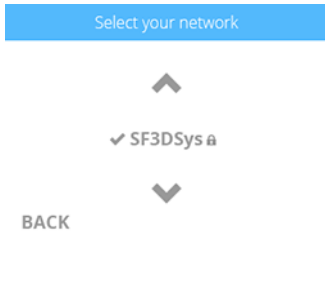

4. Select the [checkmark](#) to continue the warranty activation process.

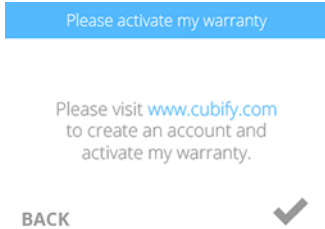

5. Log in to 3DSystems.com. Go to [www.3dsystems.com/shop/account/login](http://www.3dsystems.com/shop/account/login).



**NOTE:** You must be logged in to [www.3DSystems.com](http://www.3DSystems.com) to activate your printer. If you have not activated an account, select [SIGN UP](#) or enter your information on the [signup page](#).

6. Navigate to <http://3dsystems.com/shop/cubepro/activate>.



**NOTE:** The serial number of your printer will appear on the printer's touchscreen display. Take note of the serial number. You will need it to activate your printer. The serial number can also be found on a label adhered to the right side of the printer near the power on/off switch.



**NOTE:** This illustration provides an example of a serial number. Do not use this number to activate your printer.

7. Select the [checkmark](#) to continue.

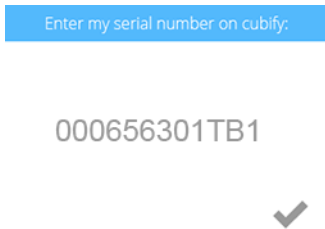

8. Enter your serial number and select [Activate](#).



**NOTE:** Your 4-digit activation code will appear. Please note the activation code because it will need to be entered into the printer's touchscreen display to activate the printer.



**NOTE:** You can access the User Guide, software for either Windows or Apple operating systems, and free creations.

9. After receiving your activation code during the registration and warranty activation process, enter your 4-digit code in the touchscreen display. Select the [checkmark](#) to continue.





NOTE: If the wrong activation code was entered, select **RETRY** and enter the activation code again.

Oops! Wrong pincodel



RETRY

10. Select the **checkmark** to complete the activation process. Your printer is now ready to print a creation.

Congratulations!

Now I'm ready to print  
anything you like!



11. To install cartridges and perform a test print, select **START**.



NOTE: Install the cartridge in cartridge bay 1 on the left side of the printer.

Next, I need cartridges installed!



BACK

START

12. Open the packaging and remove the thumbscrew from the new cartridge. Select the **checkmark** to continue.

Unpack your new cartridge



CANCEL



13. Pull out 12"/30 cm of material from the material cartridge. Select the **checkmark** to continue.

Pull out filament from cartridge



14. Cut off 2"/5 cm of print material from the end. Select the **checkmark** to continue.



NOTE: Ensure the material is not bent or creased. If the material is not straight, pull out the damaged material from the cartridge. Cut off and dispose the portion that is not straight.

Cut off end of filament



15. Insert the print material under the cartridge clamp roller of cartridge bay 1 and into the material tube. Select the [checkmark](#) to continue.

Insert filament under clamp, through tube

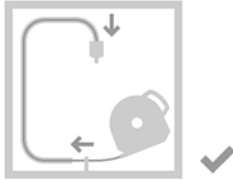

16. Continue to manually feed the print material through the material tube until it begins to extrude from print jet 1 into the jet wiper assembly. Select the [checkmark](#) to continue.



**NOTE:** When the material reaches far enough into the extruder, the extruder motor will assist with feeding the material further into the print jet.

Gently push filament in, until it jets out

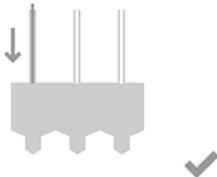

17. (1) Push the front of the cartridge into place. (2) Then, push the cartridge handle downward until the cartridge is fully seated in its cartridge bay mount. Select the [checkmark](#) to continue.

Push cartridge in place

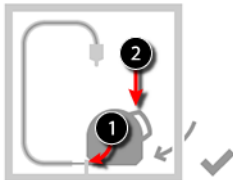

**NOTE:** Ensure the front of the cartridge (A) where the material exits is seated under the clamp roller and between the vertical alignment pins in the cartridge bay.



8. To continue with the test print, select [PRINT](#).



Press PRINT to start a test print



BACK

PRINT



NOTE: If the test print file uses a color that is not installed in the printer, select the checkmark to enable the printer to change the color of the print to a color currently installed.

Confirmation

Colors in print file do not match the colors in printer. The printer will assign colors that are loaded.

BACK



19. Apply two thin layers of Cube Glue to the print pad. Select the [checkmark](#) to continue.



NOTE: For more information, refer to the section titled [Applying Cube Glue](#).



NOTE: Apply enough glue to cover a square area of 5"/15 cm in the center of the print pad.



NOTE: For best results, ensure the glue is dry prior to printing.

Apply glue to the plate



BACK



NOTE: Print jet 1 will begin to heat.

Heating up print jet



NOTE: The printer will begin printing the welcome message test print.

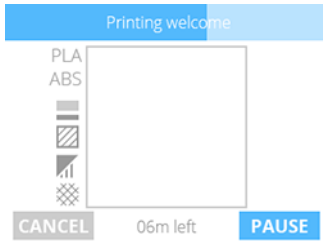

20. Select the [checkmark](#) to continue to go to the main menu.



NOTE: Please wait while the print jet cools.

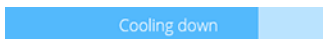

## Connecting Via USB Cable

The printer can connect to a computer running Windows® 8.1 or Windows 10 using a standard USB A to USB B cable. You can use the CubePro Print Client to prepare your files for printing or you may also use any PC application that is Windows 3D print compatible.

Compatible Applications include:

- Microsoft® 3D Builder
- Microsoft 3D Scan
- SolidWorks 2015
- Autodesk TinkerCad
- Netfabb Professional
- Autodesk Mesh Mixer
- Siemen's JT2Go
- Siemen's Solid Edge



NOTE: The USB connection is only compatible with computers running Windows 8.1 or Windows 10 operating systems.

1. Connect a USB A connector to your computer and connect the USB B connector (A) to your printer.

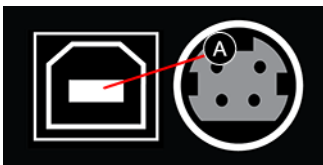

NOTE: When the USB cable is connected, Windows will automatically obtain the driver from Windows Update and install it. An internet connection is required.



NOTE: Once the driver has been installed, you can print from any Windows 3D print-compatible application using the 3D print option.

2. Once the driver has been installed, you can verify that it installed properly when you see the printer icon in the [Devices and Printers](#) section of the control panel.

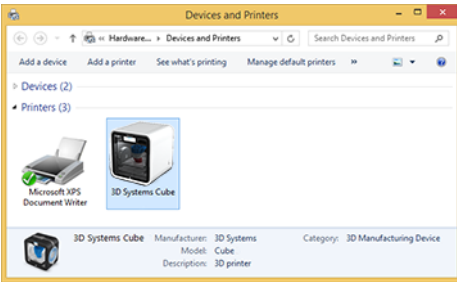

NOTE: You can also view *3D Systems CubePro* under [Printers](#) in the Device Manager.

## Menu Overview

### Touchscreen Display

After powering on the printer and turning on the touchscreen display, touch the display to continue.



**CAUTION:** When using the touchscreen, use only light finger pressure to make selections. Using anything sharp will damage the touchscreen display and will void the manufacturer's warranty.



### Print / Setup

**PRINT** allows the user to print a creation stored either on a USB mass storage device or from the CubePro software.

**SETUP** allows the user to configure the printer, connect to a wireless or ad hoc network, install cartridges, or view the printer status.

Eve, reporting for duty!



PRINT



SETUP

### Navigation

Navigation between screens is performed by pressing the right or left arrows.

Materials



## Materials

**CARTRIDGE STATUS** allows the user to view the type and color of the material that is installed. It also displays the estimated amount of material left in the cartridge. Selecting **CHANGE CARTRIDGE** allows the user to install cartridges in empty bays or replace installed cartridges.



## Print Plate Calibration

**MOVE JETS** allows the user to manually move the print jets in the X and Y directions.

**LEVEL PLATE** is a utility that assists in leveling the print pad to the print jets.

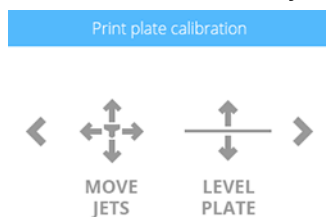

## Print Jet Calibration

**CONTROL JETS** allows the user to test the operation of the extruders and print jets.

**OFFSET JETS** is a utility that defines the parameters of the space between the print jets.



**CAUTION:** Do not change any of the values in the **OFFSET JETS** utility unless advised to do so by Cubify Support. Any changes will alter the print quality of your creations.



## Network

The **Network** menu allows the user to connect to a wireless network or to an ad hoc device.



## System

**SELECT LANGUAGE** allows the user to localize the printer to their language.

**LIGHT** allows the user to turn on or off the print jet LEDs. The other interior LEDs are managed by the firmware when the CubePro is powered on.

## System



## Advanced

Selecting the **FIRMWARE** icon allows the user to update their firmware either with a file downloaded to a USB mass storage device or by wireless connection.

By selecting **INFO**, the printer will display the printer status including the serial number, the print jet temperatures, and the name of the wireless network to which the printer is connected.

## Advanced



## Material Upgrades

**MATERIAL UPGRADES** is a utility that activates the use of optional materials within the printer once the upgrade has been purchased. Once the upgrade has been purchased on [www.cubify.com](http://www.cubify.com), you will receive an activation code that must be entered into the touchscreen display.

## Material upgrades



## Printing Your Creation

There are many 3D creations available at [3dsystems.com/shop/cubepro/downloads](https://3dsystems.com/shop/cubepro/downloads). For more information about converting a .stl file into a .cubepro file which the printer can use, refer to the section titled [CubePro Software](#).

### Printing Procedure

The following steps illustrate how to print a creation.

1. After powering up your printer and turning on your display, press the touchscreen to begin.



2. Select PRINT.



NOTE: If the file is saved on a USB mass storage device, insert the device into the USB port on the printer.



NOTE: You can also print directly from the CubePro software using a wireless connection.

Eve, reporting for duty!



PRINT



SETUP

3. Using the arrows, navigate to your file and select **PRINT**.



NOTE: The file name will be displayed at the top.



01h 25m

PRINT



NOTE: If the print file requires PLA material and ABS material is installed, the printer will prompt you to change the cartridge(s). Select [CHANGE CARTRIDGE](#) and refer to the section titled [Replacing A Material Cartridge](#).

This print requires PLA material!



CHANGE  
CARTRIDGE

BACK



NOTE: If the print file requires ABS material and PLA material is installed, the printer will prompt the user to change the cartridge(s). Select [CHANGE CARTRIDGE](#) and refer to the section titled [Replacing A Material Cartridge](#).

This print requires ABS material!



BACK



NOTE: If the print file requires ABS material but PLA is installed, the printer will prompt you to change the material cartridge. Select [CANCEL](#) and follow the instructions in the section titled [Replacing A Material Cartridge](#).

Remove PLA cartridges

Please remove all PLA cartridges before starting the print in ABS.

CANCEL



NOTE: If there is not enough material in the cartridge to complete the print, the printer will prompt the user to replace the cartridge. Select [CHANGE CARTRIDGE](#) and follow the instructions in the section titled [Replacing A Material Cartridge](#).

Not enough material for this print



BACK



NOTE: If the creation file uses color(s) that are not installed, selecting the checkmark will enable the printer to change the color of the print to a color currently installed. You can also change the cartridge by selecting [BACK](#) and following the [CHANGE CARTRIDGE](#) instructions. To change the cartridge, refer to the section titled [Replacing A Material Cartridge](#).

Confirmation

Colors in print file do not match the colors in printer. The printer will assign colors that are loaded.

BACK



4. Apply two (2) thin layers of glue to the center of the plate. Select the [checkmark](#) to continue.



NOTE: For more information, refer to the section titled [Applying Cube Glue](#).



NOTE: For small print file sizes, use a light coating of glue. For larger parts, a slightly thicker coating of glue is recommended. When the printer begins to print, the glue surface should be mostly dry. The temperature from the print material will melt the surface of the glue increasing its adhesion.



NOTE: Ensure that the area where glue is applied is larger than the base of your creation.

Apply glue to the plate



NOTE: The estimated time to completion is noted at the bottom of the screen.

Loading



NOTE: The estimated time to completion is noted at the bottom of the screen.



NOTE: When printing with ABS material, the print chamber will need to build and maintain a predetermined temperature. Ensure the top cover and the back panel have been installed. The front door must be closed.



NOTE: When printing with PLA only or both PLA and ABS material, the print chamber will not need to be preheated.

Heating up the chamber



CANCEL



NOTE: The print jets required for the print job will begin to heat.



CAUTION: Do not touch the print jets until they have cooled to room temperature.

Heating up print jet



NOTE: The blue bar at the top is a progress indicator. Select **PAUSE** to temporarily stop printing. Select **CANCEL** if you wish to cancel the print job.



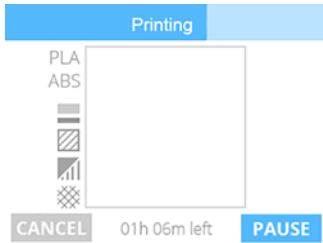

NOTE: Once printing has been paused, select [RESUME](#) if you wish to continue printing.



NOTE: To cancel the print job, select [CANCEL](#) to confirm your decision. Otherwise, select [RESUME](#) to continue printing.

Are you sure you want to cancel the print?



[CANCEL](#)

[BACK](#)

5. Once the printer has finished printing, select the [checkmark](#) to continue.



NOTE: The print jets will cool down after your creation has finished printing.



CAUTION: Do not touch the print jets until they have cooled to room temperature.

Cooling down



6. Refer to the section [Finishing Your Creation](#) for information about removing your creation from the

print pad and the procedure for cleaning the creation and the print pad.

## Finishing Your Creation

### Removing Your Creation From The Print Pad



**CAUTION:** Before attempting to remove your creation from the print pad, ensure that the CubePro has finished printing. Once printing has completed, the print platform and print pad will move to the bottom of the printer.

1. Grasp both sides of the print pad, lift upward and remove it from the print platform.
2. Submerge the print pad and the base of the part in warm water for twenty (20) minutes.



**NOTE:** If you can not submerge the print pad in warm water, run hot water over the base of the part for twenty (20) minutes.

3. Using the print pad cleaner (scraper) included in the tool kit, gently release your creation from the print pad.



**NOTE:** The appearance of your scraper may differ from the illustration.

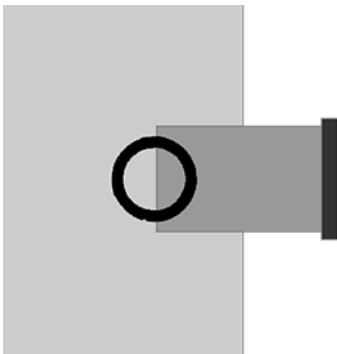

4. Rinse your creation under hot water to ensure all of the glue has been removed.
5. Rinse the print pad under water to clean off any remaining glue.
6. Dry the print pad completely before reinstalling it into the printer.



**CAUTION:** Failure to completely dry the print pad before reinstalling it into the printer can damage sensitive electrical components and void the manufacturer's warranty.

### Removing Rafts

A raft is the flat support structure that is attached to the base of your creation if you enabled that option when building the .cubePro file. Though it is recommended that printing be done without a raft, some larger, more complicated parts may require one.

**ABS Raft / PLA Part** ABS rafts can be peeled away from PLA parts.

**PLA Raft / ABS Part** PLA rafts can be pulled from ABS parts.

**ABS Raft / ABS Part** Use pliers to pull away as much of the raft as possible. Then use a rough-grade sandpaper to remove the remaining raft material, followed by a fine-grade wet and dry sandpaper to achieve a smoother finish.

**PLA Raft / PLA Part** Use pliers to pull away as much of the raft as possible. Then use a rough-grade sandpaper to remove the remaining raft material, followed by a fine-grade wet and dry sandpaper to achieve a smoother finish.

### Removing Sidewalks

A sidewalk (A) is a mesh boundary that prints around the outside diameter of the part. Its main purpose is to reduce the tendency of warping especially when printing flat parts with ABS material. They are not recommended for parts that have fine details.

Sidewalks are designed to easily break away from a part once it has been removed from the print pad.



### Removing Supports

Supports are used when printing creations that need a supporting structure to print properly. When using PLA or ABS as a support material, peel the supports away from the part. Then, using

wire cutters, cut away the support structure from your creation. Once the supports have been cut away, use fine-grade sandpaper (not included) to finish smoothing the part.

When using **Infinity Rinse-Away™** support material, run warm water over the part until the part can be removed from the print pad. Submerge the part in warm water until the supports begin to soften. Pull the supports away from the part using pliers. With most of the support material removed, use a blunt-edged pick or toothbrush to remove residual support material from holes and crevices. To remove support material from moving parts or areas that are difficult to reach, it is recommended that the part is allowed to soak in water for several hours. Then, rinse the part under running warm water to ensure all supports have been removed.



### Removing Supports - Optional Ultrasonic Support Removal Tank

The Ultrasonic Support Removal Tank automatically removes PLA support material from ABS models. There are two methods for removing or weakening the material.

Method	Advantages	Disadvantages
<b>Hot Water</b>	<ul style="list-style-type: none"><li>• Corrosive chemicals are not used.</li></ul>	<ul style="list-style-type: none"><li>• Support material requires physical force to crumble away.</li><li>• Support material in hidden cavities may remain if the user is unable to reach them.</li><li>• The process can be more lengthy.</li></ul>
<b>Caustic Soda</b>	<ul style="list-style-type: none"><li>• Support material is quickly removed.</li><li>• Support material hidden in cavities will be dissolved without physical force.</li></ul>	<ul style="list-style-type: none"><li>• Requires health and safety procedures.</li></ul>

### Hot Water Method



**CAUTION:** This process uses hot water (approximately 80°C or 176°F). Wear all Personal Protective Equipment (PPE).



**CAUTION:** Do not operate without water in the cleaning tank. Damage may occur.



**CAUTION:** Never use boiling water. Damage may occur.



**CAUTION:** The unit must be positioned on a flat, stable work surface. Do not tip over or move the tank during its operation. Electrical equipment can become damaged when exposed to water or other fluids.

1. Pour 0.75 liters (0.79 quarts) of water into the tank.
2. Place the models to be cleaned into the tank.
3. Close the lid.
4. Connect the power supply and press the power button to turn on the tank.
5. Set the temperature to 80°C (176°F). Use the -5 and +5 buttons to lower or increase the temperature.
6. Set an alarm for 48 hours.



**NOTE:** Do not use the timer on the tank. This is intended for the ultrasonic operation used with the Caustic Soda method and will only run for 180 minutes.

7. After 48 hours, remove the model from the tank using the included plastic tongs and immediately run cold water over it for 1 to 2 minutes.



**NOTE:** Ensure the Ultrasonic Support Removal tank has been turned off.

8. After the model has been thoroughly washed, the PLA support material should easily crumble away.



NOTE: A blunt knife can be used to scrape the support away from the model. Additional rinsing may help flush remaining support material fragments from the model.

## Caustic Soda Method



**WARNING: CAUSTIC SODA CAN BURN SKIN AND EYES, IF HANDLED IMPROPERLY. NEVER HANDLE CAUSTIC SODA WITHOUT USING THE FOLLOWING PERSONAL PROTECTIVE EQUIPMENT (PPE): GLOVES, GOGGLES AND TONGS. IF CAUSTIC SODA TOUCHES THE SKIN, WASH IT AWAY IMMEDIATELY. IF CAUSTIC SODA TOUCHES THE EYES, IMMEDIATELY USE AN EYEWASH TREATMENT.**



CAUTION: Never operate the unit without water in the cleaning tank. Damage may occur.



CAUTION: Never use boiling water. Damage may occur.



CAUTION: The unit must be positioned on a flat, stable work surface. Do not tip over or move the tank during its operation. Electrical equipment can become damaged when exposed to water and other fluids.

1. Fill the tank with 0.75 liters (0.79 quarts) of cold water.



**WARNING: DO NOT ENGAGE THE ULTRASONIC FEATURE WHILE STIRRING IN THE CAUSTIC SODA. THIS WILL CAUSE THE SOLUTION TO VAPORIZE.**



**WARNING: ENSURE THE AREA IS WELL VENTILATED AND DO NOT DIRECTLY INHALE THE VAPOR FROM THE TANK.**

2. Using scales and a measuring bowl, measure out 200 grams of caustic soda.
3. Pour the caustic soda into the tank in approximately 40-gram increments, stirring thoroughly after each addition.



NOTE: Stirring is essential to ensure the caustic soda granules do not collect at the bottom of the tank.

4. Immediately clean the measuring bowl and scales to ensure removal of all caustic soda.
5. Using plastic tongs and all the recommended personal protection equipment, gently lower the model into the caustic soda solution.



CAUTION: Exercise caution so that none of the solution spills.

6. Close the lid.
7. Connect the power supply and press the power button to turn on the tank.
8. For best results, set the temperature to 60°C. Use the -5 and +5 buttons to lower or increase the temperature.



**WARNING: DO NOT SET THE TEMPERATURE ABOVE 60°C AS THE REACTION BETWEEN THE CAUSTIC SODA AND THE WATER IS EXOTHERMIC, AND WILL CONTINUE TO ELEVATE THE TEMPERATURE. ACTUAL TEMPERATURE SHOULD NEVER EXCEED 80°C.**

9. Once the tank has reached 60°C, use the -5 and +5 buttons to set the timer for 180 minutes.



NOTE: The ultrasonic process will begin as soon as you have set the time.

10. After 180 minutes, remove your model from the tank using plastic tongs and run it under cold water for 1-2 minutes.



CAUTION: Continue wearing the recommended personal protection equipment when handling the model until the process has been completed.



NOTE: All support material should have dissolved. Any remaining supports can be crumbled or scraped away with a blunt knife or rinsed off in the sink.

11. Empty the caustic solution from the Ultrasonic Support Removal Tank.



NOTE: It is safe to pour it in the sink as caustic soda can be used as a drain cleaner.

12. Rinse the tank and refill it with 0.75 liters of water.
13. Using plastic tongs, place the model back into the tank.
14. Once all of the caustic soda has been cleaned from the area, you may remove your personal protection equipment.
15. Repeat the ultrasonic process with clean water for 30 minutes at 60°C to remove any caustic soda residue that may remain on the model.
16. Once the ultrasonic process has completed the second time, use plastic tongs to remove the model from the ultrasonic tank.
17. Rinse it under cold water for 1-to-2 minutes.

## CubePro Software

CubePro software is an easy-to-use tool that simplifies the printing process. The software is available by logging in to your <http://3dsystems.com/shop> account. Downloads are available for Windows and Mac operating systems.

### Installing Windows Software

1. Go to [www.3dsystems.com/shop](http://www.3dsystems.com/shop) and log in with your username and password.
2. Navigate to [3dsystems.com/shop/cubepro/downloads](http://3dsystems.com/shop/cubepro/downloads). Select **Windows** from the Software Download section at the bottom of the page. You can also download the software by clicking [here](#).
3. Run the installer file.
4. Read through the End-User License Agreement. If you accept the terms of the agreement, select the acceptance checkbox and select **Next**.

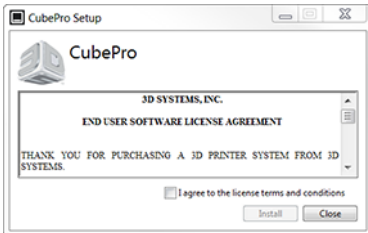

**NOTE:** The software will begin to install.

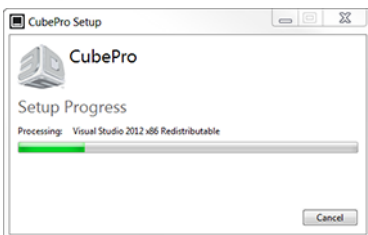

5. Select **Close** once the software has been installed.

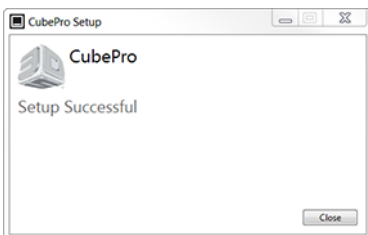

### Installing MAC Software

1. Go to [www.3dsystems.com/shop](http://www.3dsystems.com/shop) and log in with your username and password.
2. Navigate to [3dsystems.com/shop/cubepro/downloads](http://3dsystems.com/shop/cubepro/downloads). Select Mac from the Software Download section at the bottom of the webpage. You can also download the installer file by clicking [here](#).
3. Select the **Downloads** icon on the Dock and select the CubePro .dmg file.
4. Drag the CubePro file into the Applications folder.



## Software Overview

CubePro software enables the user to import .stl creation files, specify the material type and color, and then orient, scale, size and rotate the models. Before the printer can print a file, the software must slice it into layers during the build process. This process converts a .stl file to a .cubepro file which is the file type the printer can print. Once a .cubepro file has been generated, this print file can no longer be edited although the original .stl file can be used again to create another .cubepro file.

**STL Files:** Files that can be imported and edited prior to building a .cubepro file.

**CUBEPRO Files:** Files that have been prepared, sliced into layers, and are ready to print.



**NOTE:** The CubePro software interface for Mac may differ in color from the Windows version but the functionality will be the same.

## Home Tab

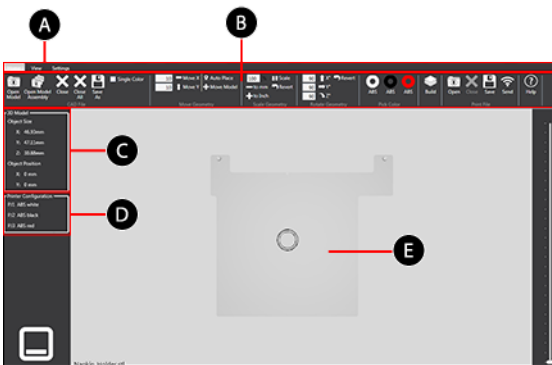

**A** Interface Tabs

**B** Tool Ribbon

**C** Model Size and Position

**D** Print Material Configuration

**E** Print Pad



## CAD File Functions

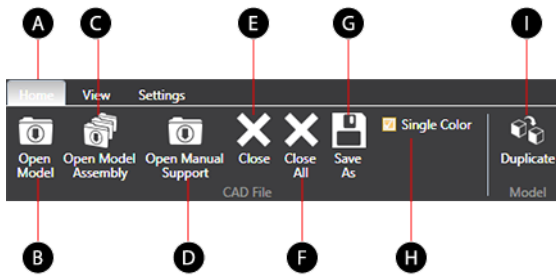

- |          |                            |   |          |                     |  |
|----------|----------------------------|---|----------|---------------------|--|
| <b>A</b> | <b>Home Tab</b>            | The main tab                              | <b>F</b> | <b>Close All</b>    | Closes all open .stl files                                 |
| <b>B</b> | <b>Open Model</b>          | Opens a .stl file                         | <b>G</b> | <b>Save As</b>      | Saves the current .stl file                                |
| <b>C</b> | <b>Open Model Assembly</b> | Opens a multi-part assembly of .stl files | <b>H</b> | <b>Single Color</b> | Check the box if the model will print using a single color |
| <b>D</b> | <b>Open Manual Support</b> | Import nylon manual supports              | <b>I</b> | <b>Duplicate</b>    | Creates a duplicate of a selected part                     |
| <b>E</b> | <b>Close</b>               | Closes an open .stl file                  |          |                     |  |

## Geometry Functions

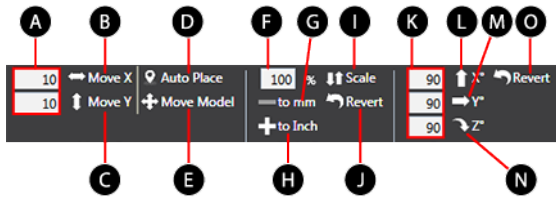

- |          |                                       |   |          |                                     |   |
|----------|---------------------------------------|---|----------|-------------------------------------|---|
| <b>A</b> | <b>Movement Geometry Value Fields</b> | Enter the appropriate values to move the model.   | <b>I</b> | <b>Scale</b>                        | Scale the model by the specified percentage.                          |
| <b>B</b> | <b>Move X Button</b>                  | Once a value has been entered, select the button to move the model left or right.       | <b>J</b> | <b>Revert</b>                       | Undo the scaling and revert back to the original size.                |
| <b>C</b> | <b>Move Y Button</b>                  | Once a value has been entered, select the button to move the model forward or backward. | <b>K</b> | <b>Rotate Geometry Value fields</b> | Enter values to rotate the model                                      |
| <b>D</b> | <b>Auto Place</b>                     | Auto Place the model to the center of the print area.                                   | <b>L</b> | <b>X</b>                            | Rotate the model front-to-back on the X axis by the specified value.  |
| <b>E</b> | <b>Move Model</b>                     | Once this button has been selected, left click on the model and drag it into position.  | <b>M</b> | <b>Y</b>                            | Rotate the model left and right on the Y axis by the specified value. |
| <b>F</b> | <b>Scale Value Field</b>              | Enter the scale percentage  | <b>N</b> | <b>Z</b>                            | Rotate the model up and down on the Z axis by the specified value.    |
| <b>G</b> | <b>- to mm</b>                        | Scale the 3D model to the millimeter value entered in the field.                        | <b>O</b> | <b>Revert</b>                       | Undo the applied rotation and revert to the original position.        |
| <b>H</b> | <b>+ to Inch</b>                      | Scale the 3D model to the inch value entered in the field.                              |          |                                     |   |

## Color, Build, Print File And Help

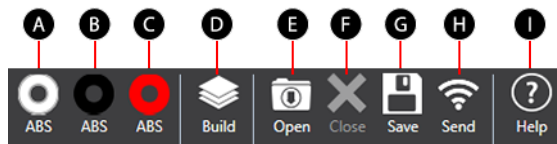

- A** **Material 1** ColorSelect shells to be rendered by print jet 1
- B** **Material 2** ColorSelect shells to be rendered by print jet 2
- C** **Material 3** ColorSelect shells to be rendered by print jet 3
- D** **Build Button** Process the 3D model to obtain a print file
- E** **Open** Open a print file
- F** **Close** Close a print file
- G** **Save Print File** Save a build print file
- H** **Send** Send a print job through the wireless network to a connected printer
- I** **Help** Help menu

## View Tab

### Zoom And View

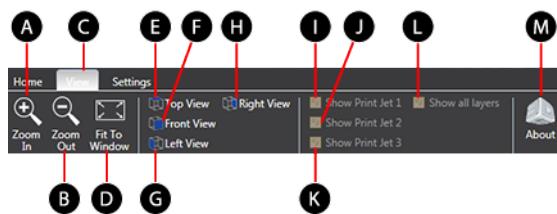

- A** **Zoom In** Zoom in on the model
- B** **Zoom Out** Zoom out on the model
- C** **View Tab** Contains Zoom, View and Print Path tools
- D** **Fit to Window** Fit the model to the center of the window.
- E** **Top View** Select the button to view the top of the model
- F** **Front View** Select the button to view the front of the model
- G** **Left View** Select the button to view the left side of the model
- H** **Right View** Select the button to view the right side of the model
- I** **Show Print Jet 1** Show print jet 1 print path
- J** **Show Print Jet 2** Show print jet 2 print path
- K** **Show Print Jet 3** Show print jet 3 print path
- L** **Show All Layers** Show all the tool path layers
- M** **About** Software version and update information link

## Settings Tab

### Settings Toolbar

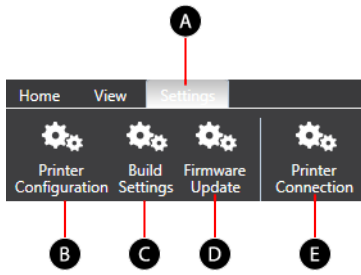

- A Settings Tab** Adjust the settings.
- B Printer Configuration** Set the printer type, number of print jets and printer materials.
- C Build Settings** View and select the build settings used when creating the tool path for the print file.
- D Firmware Update** Update the printer firmware.
- E Printer Connection** Setup a wireless connection with the printer.

## Printer Configuration

### Printer Configuration

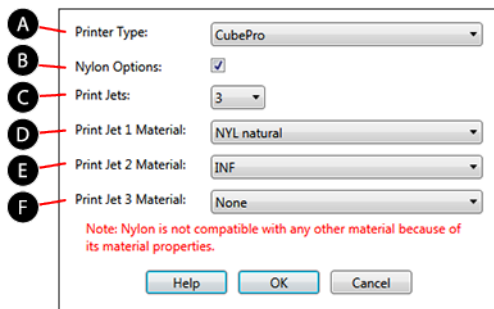

- A Printer Type** Select your printer type
- B Nylon Options** Select Nylon Options when printing with nylon
- C Print Jets** Set the number of print jets in your printer
- D Print Jet 1 Material** Select the type and color of material installed in cartridge bay 1
- E Print Jet 2 Material** Select the type and color of material installed in cartridge bay 2
- F Print Jet 3 Material** Select the type and color of material installed in cartridge bay 3

## Build Settings

### Build Settings

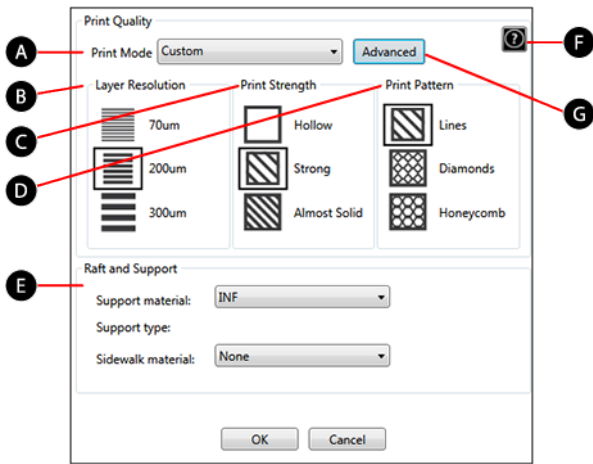

- A Print Mode** The software has four modes including 3 set modes and one custom mode.
- B Layer Resolution** The detail and smoothness of a part.
- C Print Strength** The strength of the inner structure of a creation.
- D Print Pattern** The design of the inner structure of a creation.

- E Raft and Support** Selection of the types of materials used to create rafts, supports and sidewalks.
- F Advanced** Adjustments to print pattern fill and the creation shell.
- G Help** Opens the help menu.

## Descriptions

### Print Mode

<b>Standard</b>	<ul style="list-style-type: none"> <li>• Layer Resolution: 200um</li> <li>• Print Strength: Strong</li> <li>• Print Pattern: Diamonds</li> </ul>
<b>Premium</b>	<ul style="list-style-type: none"> <li>• Layer Resolution: 70um</li> <li>• Print Strength: Strong</li> <li>• Print Pattern: Diamonds</li> </ul>
<b>Draft</b>	<ul style="list-style-type: none"> <li>• Layer Resolution: 300um</li> <li>• Print Strength: Strong</li> <li>• Print Pattern: Lines</li> </ul>
<b>Custom</b>	Custom allows the user to customize their print settings

### Print Resolution

<b>0.070</b>	<ul style="list-style-type: none"> <li>• Great mode for parts requiring smooth surfaces</li> <li>• Layer lines are not very visible in these parts</li> <li>• Good mode for artistic parts with a smooth flow</li> <li>• Not the best mode for fine detail</li> </ul>
<b>0.200</b>	<ul style="list-style-type: none"> <li>• Best mode for general printing and most compatible mode for a wide range of geometries</li> <li>• Fine detail preservation for things like steeples, spires, sharp points, or thin walls</li> </ul>
<b>0.300</b>	<ul style="list-style-type: none"> <li>• A fast mode with thicker layers</li> <li>• Good for large parts with minimal detail</li> </ul>

### Print Strength

<b>Hollow</b>	<ul style="list-style-type: none"> <li>• Fastest mode to produce a part</li> <li>• Hollow has fewer outer surfaces and larger print pattern spacing</li> <li>• Best for parts that will not be stressed</li> </ul>
<b>Strong</b>	<ul style="list-style-type: none"> <li>• Medium amount of outer surfaces and smaller print pattern spacing</li> <li>• Best for parts that will have minimal physical abuse</li> <li>• The most surfaces and the tightest print pattern spacing</li> </ul>
<b>Almost Solid</b>	<ul style="list-style-type: none"> <li>• The most robust part</li> <li>• Best for parts that will be stressed</li> </ul>

### Print Pattern

<b>Lines</b>	<ul style="list-style-type: none"> <li>• Fastest print fill pattern</li> <li>• Minimal cross bracing</li> </ul>
<b>Diamonds</b>	Strong print pattern with 2-direction cross bracing
<b>Honeycomb</b>	Strong print pattern with 3-direction cross bracing

## Advanced Build Settings

The Advanced Build Settings utility allows you to customize the layer thickness of the Print Pattern Fill, Shell Options and Sidewalk Options as well as enabling or disabling Support Borders or Draw Fine Features.

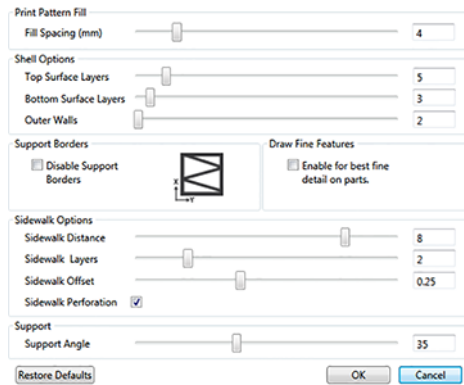

### Print Pattern Fill

Fill Spacing is the amount of space between interior supports. Lower values increase the interior strength of the creation.

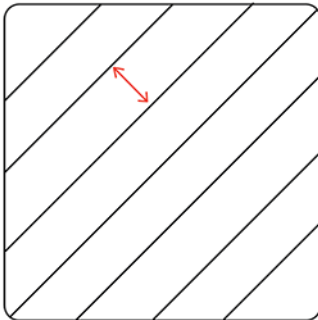

### Shell Options

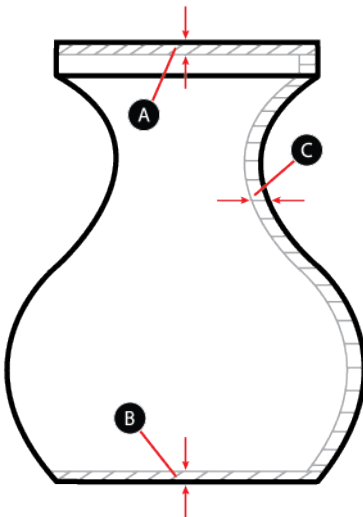

- A Top Surface Layers** Increase the value for a thicker top surface layer.
- B Bottom Surface Layers** Increase the value for a thicker bottom surface layer.
- C Outer Walls** Increase the value for increased strength of the outer walls.

## Support Borders

Support borders (A) reinforce supports (B) for overhanging parts and should not be used for holes and cavities (C).

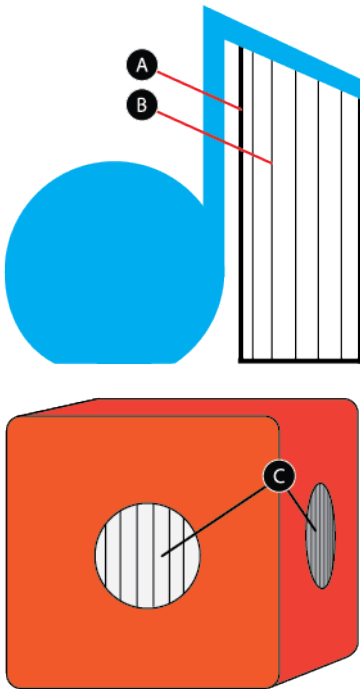

## Draw Fine Features

Select the enable checkbox when printing small parts with fine features. For larger parts needing more accuracy, this feature should not be enabled.

## Sidewalk Options

A sidewalk is a mesh boundary that prints around the outside diameter of the part. Its main purpose is to reduce the tendency of warping especially when printing flat parts with ABS material. They are not recommended for parts that have fine details. Sidewalks are designed to easily break away from the part once it has been removed from the print pad.



NOTE: A sidewalk will not print under a part and will not fill holes or cavities within the border of the part.

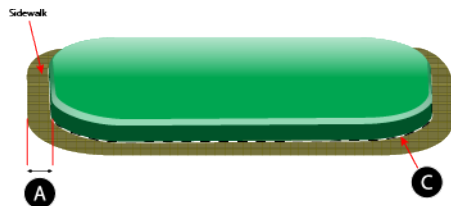

A

**Sidewalk Distance**

Set the distance the sidewalk extends beyond the border of the part.

B

**Sidewalk Layers**

Set the number of layers that will be printed.

C

**Sidewalk Offset**

Set the distance between the part and the sidewalk.

D

**Sidewalk Perforation**

Enabling this option will create a perforated intersecting line at the border of the part for easier removal.

## Firmware Update

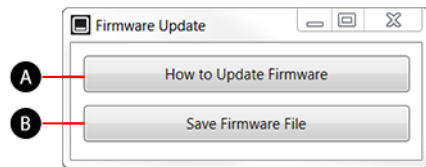

- A How to Update Firmware** Instructions for updating firmware in your CubePro
- B Download Firmware** Download firmware to a mass storage device

## Printer Connection

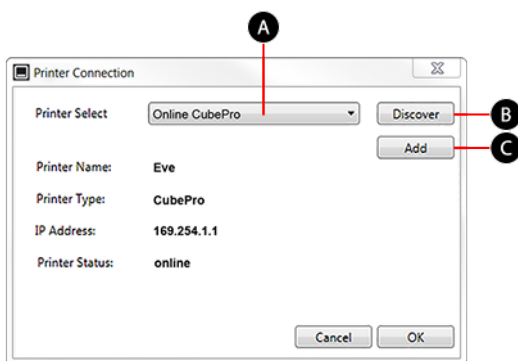

- A Printer Select** Select the printer connection
- B Discover** Find an applicable printer on the network
- C Add** Add a printer using the printer's IP address

## Nylon Manual Supports

### Using Nylon Manual Supports

When printing with nylon, parts with large, flat overhanging features may warp. CubePro software provides readily-accessible nylon supports for your nylon-printed parts.



**NOTE:** The use of nylon manual supports requires INF support material to also be installed in the printer and used as a support material type when setting the build settings. INF support material is to be used in addition to the nylon supports you will add to the part.

1. After loading your part to the print pad, select [Open Manual Support](#).

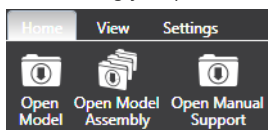

2. Select the supports you will need by their height.



**NOTE:** The height is noted by the variables after the last X in the file name. You may have to keep trying different support sizes until you find the one that contacts the bottom surface of the part needing support.

Name	Type
2.5x5x150	STL File
2.5x5x145	STL File
2.5x5x140	STL File
2.5x5x135	STL File
2.5x5x130	STL File
2.5x5x125	STL File
2.5x5x120	STL File
2.5x5x115	STL File
2.5x5x110	STL File
2.5x5x105	STL File



NOTE: It is okay for the support to be taller than the bottom surface but the support should not extrude above the part.

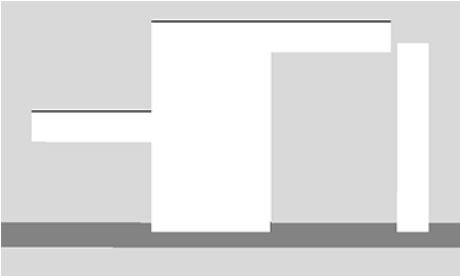

3. Add as many supports as you will need knowing that INF material will be printed around the supports providing additional stability.



NOTE: For best results, place supports under the corners of overhanging features.



NOTE: Once you move the supports into position, adding additional manual supports will reset all of them and each one will have to be repositioned.

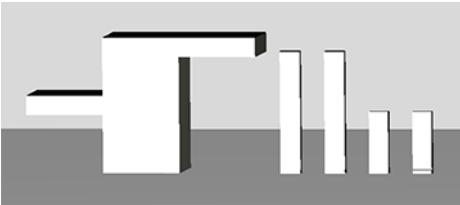

4. Select [Move Model](#).

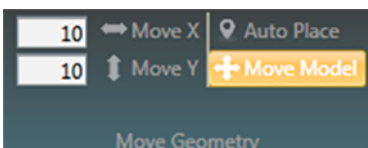

5. Select the support you would like to move and drag it into position.



NOTE: It may be helpful to zoom in to the image before positioning the supports.



6. Move each support into position. When finished, select [Move Model](#) to deselect it.



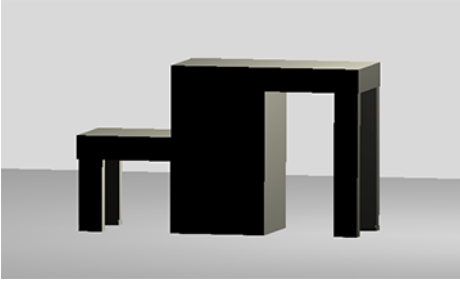

7. Ensure your color has been assigned and select **Build**.

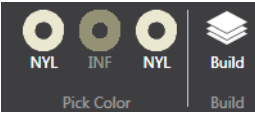

8. Select **INF** from the Support Material drop down menu. Then, select **Build**.

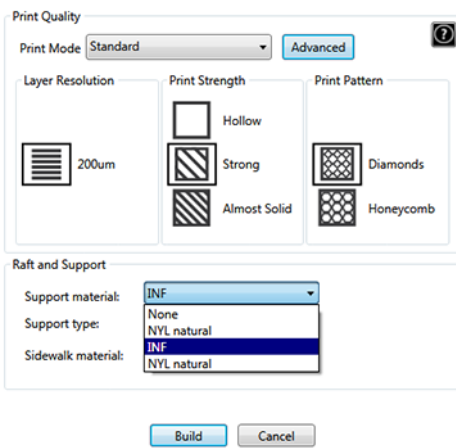

9. Save the file to your desired location.



**NOTE:** INF material will surround manual supports that are inset under an overhanging feature.

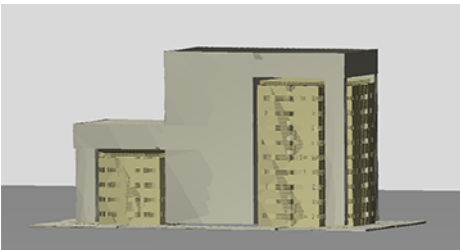

**NOTE:** Taller manual supports feature a band (A) that enables INF material to print around it for added support.

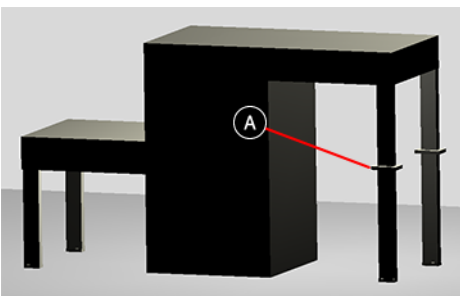

**NOTE:** You can place manual supports at the edge of your part and INF material will print to the band for additional support.

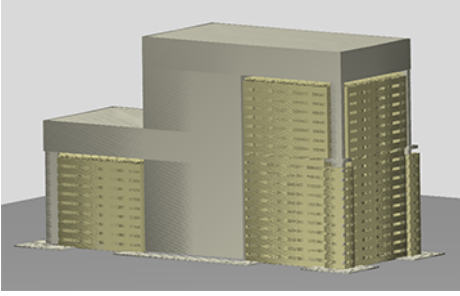

## Preparing And Printing A Creation



**WARNING: THE PRINT JETS BECOME EXTREMELY HOT DURING SETUP AND OPERATION. DO NOT TOUCH THE PRINT JETS.**



**CAUTION: Do not change the material cartridge color or material type during printing. Doing so may damage the printer.**

The CubePro software client includes useful tools to place a creation in the optimum position for printing. The model can be moved or rotated using the mouse.

- Pan/Zoom:** Rotate the mouse wheel in either direction
- Rotate the Print Pad:** Left-click and drag the mouse to change the view of the model
- Move the Print Pad:** Right-click and drag the mouse to move the print pad.

1. Select [Open Model](#).



NOTE: Select [Open Model Assembly](#) if there are multiple parts in the model.

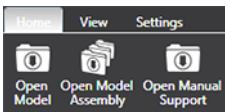

2. Browse to the creation file and select [Open](#).



NOTE: The creation or assembly will appear on the print pad.



NOTE: You can also open multiple creations on the same print pad.

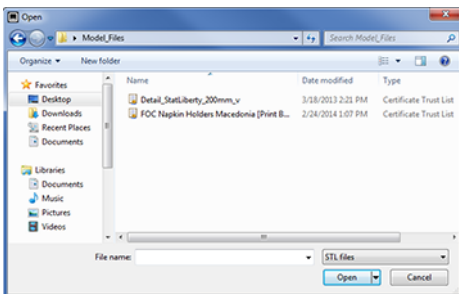

NOTE: To open .cubepro files, select Open from the Print File menu, browse to the creation file and select Open.

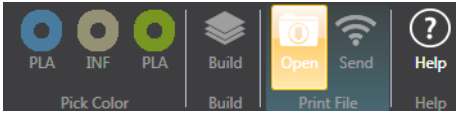

3. If your creation requires a single color, select the Single Color checkbox from the Home tab.



4. Move the model into the preferred position on the print pad.



NOTE: You can specify the distance you want to move the model by inputting values in the Move X or Move Y fields and then selecting Move X or Move Y.



NOTE: Auto Place allows the software to place the model in an optimum position.



NOTE: Selecting Move Model allows you to click and drag the model around the print pad.

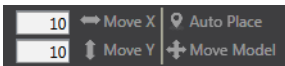

5. If necessary, scale and rotate the model by entering the values and selecting the corresponding buttons.

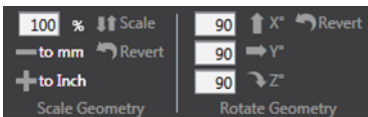

6. Select the color you wish to use and then select the part.



NOTE: If working with an assembly, select a color and then the part you wish to change.



NOTE: If you need to replace a cartridge for a different color or material type, refer to the section [Replacing A Material Cartridge](#). Then, verify the material type and color by reviewing the Printer Configuration settings under the Settings tab in the software.

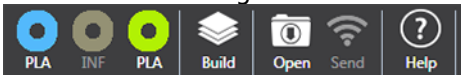

7. Select the color again to deselect it.

8. Select **Build**.

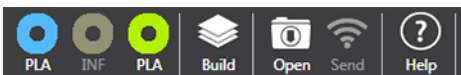

9. Enter the appropriate build settings and select **Build**.



NOTE: Refer to the section called Build Settings under the View Tab for more information.

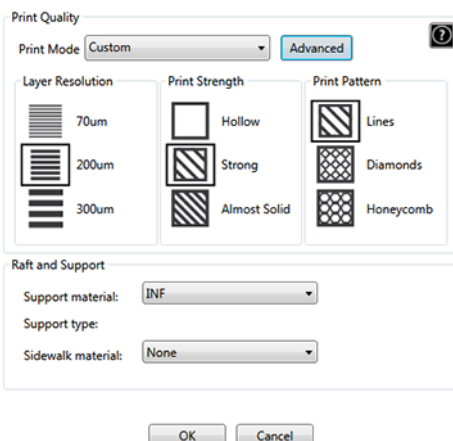

10. Browse to the location where the file will be saved and enter a file name. Select [CubePro Build Files](#) as Save As Type. Select [Save](#).

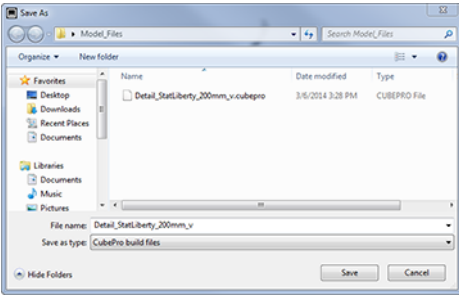

**NOTE:** The build file may take a few minutes to create. During this time, the file is being converted from a .stl file to a .cubepr file.

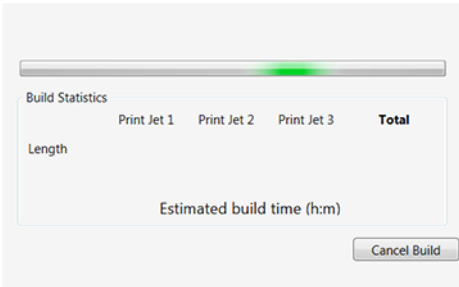

**NOTE:** Once the build is complete, the estimated print time will appear. Select [OK](#) to close the window.

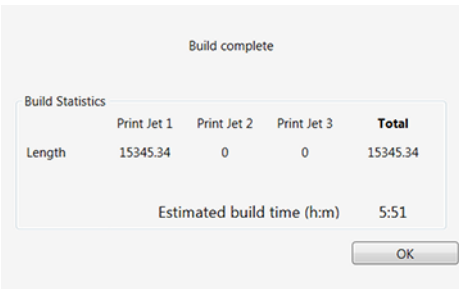

**NOTE:** Once the file has been built, it must be sent to the printer. There are two ways to send the file:

- Wireless
- USB Mass Storage Device



**NOTE:** Larger files will take longer to send to the printer using a wireless connection. Transferring larger files with a USB mass storage device is strongly recommended.

11. To save to a USB mass storage device, select [Save](#). Browse to the connected mass storage device and select [Save](#). If sending wirelessly, go to step 13.



**NOTE:** The file must be stored in the root directory of the USB mass storage device.



12. Insert the USB mass storage device into the printer's USB inlet port. Proceed to step 14.

13. To send the file to the printer using the wireless utility, select [Send](#).



14. Select **PRINT** on the printer touchscreen display.



**NOTE:** Refer to the section titled [Printing Your Creation](#) for more information.

Eve, reporting for duty!



**PRINT**



**SETUP**

## Operation Procedures

### Applying Cube Glue

Cube Glue contains water-soluble glue that adheres the part to the print pad. It is important that glue is applied to the print pad before starting any print to ensure that the creation does not move during the printing process.

The glue contains a foam applicator under the cap. It is recommended that the bottle is turned upside-down with the cap on to allow the glue to settle into the applicator before applying.

For best results, apply two thin layers of glue to the print pad using slow circular motions when prompted by the touchscreen display. Apply the glue in a pattern that is slightly larger than the footprint of the creation you are printing.

#### Layer 1

Apply a thin layer of glue to the print pad:

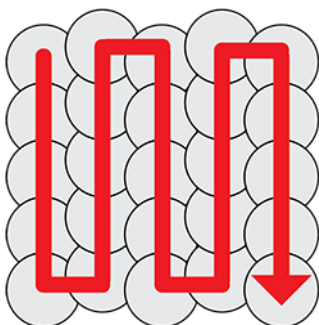

#### Layer 2

Apply a second thin layer of glue to the print pad in the opposite direction:

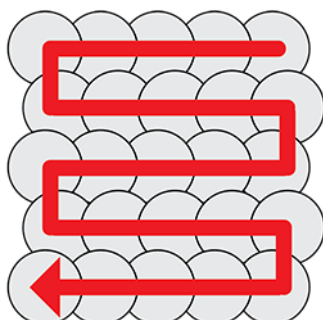

NOTE: For best results, allow the glue to dry before printing.

### Using Advanced Material

Printing with advanced materials requires the purchase of both the advanced material upgrade and the nozzle upgrade kit. After purchasing the advanced material upgrade, you will receive an 8-digit activation code that will be required to activate the printer functionality. To print advanced materials, nozzle 2 must be replaced with the special nozzle designed specifically for advanced materials.



**CAUTION:** Nozzles designed for standard materials should never be used to print advanced materials.

Advanced materials include:

- Wood
- INF
- FLEX



NOTE: Refer to the print jet replacement guide when installing the nozzle upgrade kit.

## Activation

1. Select **SETUP** from the home screen.

Eve, reporting for duty!



2. Select **NOZZLE UPGRADE**.

Nozzle Upgrade



3. Go to [www.3dsystems.com/shop](http://www.3dsystems.com/shop) and purchase the advanced material upgrade and upgrade kit.



**NOTE:** Once you have purchased the upgrade and the nozzle upgrade kit, you will receive a 8-digit activation code. Note the activation code because it will need to be entered into the printer to activate your advanced material upgrade.

4. Once you have purchased the upgrade and the nozzle upgrade kit, select the **checkmark** to continue.

Nozzle Upgrade

Please visit [www.cubify.com](http://www.cubify.com)  
to purchase the CubePro nozzle  
upgrade kit

BACK



5. Enter your 8-digit activation code and select the **checkmark** to continue.

Enter the nozzle upgrade activation code



BACK



**NOTE:** IF the wrong activation code was entered, select **RETRY**.

Wrong nozzle upgrade activation code!



RETRY

6. Select the **checkmark** to complete the upgrade activation.

Nozzle Upgrade Successful

The nozzle upgrade  
has been successful



### Select The Nozzle Type

To print advanced materials, you need to set the nozzle type to UPGRADE NOZZLE in the menu. When nozzle 2 has been set to print advanced materials, only Flex, Wood and INF can be loaded in cartridge bay 2.

1. Select **NOZZLE UPGRADE**.

Nozzle Upgrade



2. If you have installed the advanced material nozzle upgrade kit, select **UPGRADE NOZZLE** and then select the checkmark to continue.

Select Extruder 2 Nozzle Type



3. Select the **checkmark** to continue.

Extruder 2 Nozzle Type

Upgrade nozzle  
has been activated

BACK



### Installing A Material Cartridge

Before the printer will print a creation, the correct type of cartridge(s) must be installed in the printer. If the printer recognizes that no cartridge has been installed, the display will prompt you to install the appropriate cartridge.

1. Select **CHANGE CARTRIDGE** from the SETUP menu.

Materials



2. Select the cartridge to be installed.



Select cartridge to change

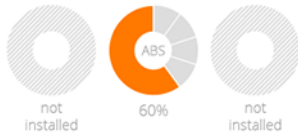

BACK



NOTE: The print jet will begin to heat.

Heating up print jet



3. Open the packaging and remove the thumbscrew from the new cartridge. Select the [checkmark](#) to continue.

Remove thumbscrew from new cartridge



CANCEL

4. Pull out 12"/30 cm of material from the cartridge. Select the [checkmark](#) to continue.

Pull out filament from cartridge



5. Cut off 2"/5 cm of material from the end. Select the [checkmark](#) to continue.



NOTE: Ensure the material is not bent or creased. If the material is not straight, pull out the damaged material from the cartridge. Cut off and dispose the portion that is not straight.

Cut off end of filament



6. Insert the material under the clamp roller and into the material tube. Select the [checkmark](#) to continue.

Insert filament under clamp, through tube

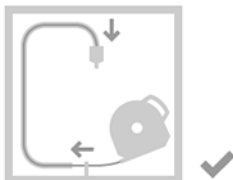

7. Gently push the print material into the print jet until print material extrudes into the jet wiper. Select the [checkmark](#) to continue.



**NOTE:** When the material reaches far enough into the print jet area, a motor will assist with feeding the material into the print jet.

Gently push filament in, until it jets out



8. (1) Push the front of the cartridge into place. (2) Then, push the cartridge handle downward until the cartridge is fully seated in its mount. Select the [checkmark](#) to continue.



**NOTE:** Ensure the front of the cartridge (A) where the material exits is seated under the clamp roller and between the vertical alignment pins in the cartridge bay.

Push cartridge in place

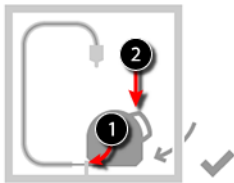

**CAUTION:** If replacing the third cartridge, be sure to rotate the second bay cartridge to its vertical position before selecting the checkmark.

Rotate cartridge back to vertical position

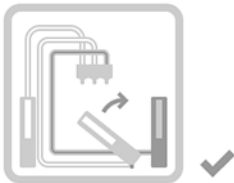

**NOTE:** The print pad must be calibrated before printing your first creation. For more information, refer to the following section titled [Calibrating The Print Pad](#).

## Replacing A Material Cartridge

The CubePro can utilize up to three installed cartridges depending on your printer model. The creation you wish to print may require a different color or material, or there may not be enough material left in the cartridge to complete your next print. Refer to the following steps to replace material cartridges.



**NOTE:** When replacing the right side cartridge in a printer with 3 cartridges installed, the center cartridge is hinged to allow the cartridge to rotate to its left side rather than removing it completely. This provides enough access to replace the right side cartridge.

1. Select [SETUP](#) from the home screen.

Eve, reporting for duty!



PRINT



SETUP

2. Select **CHANGE CARTRIDGE** from the Materials screen.



**NOTE:** Selecting Cartridge Status will show the estimated amount of material remaining in the installed cartridges. It also indicates the color and type of material being used.

Materials



CARTRIDGE  
STATUS

CHANGE  
CARTRIDGE

3. From the Select Cartridge to Change screen, select the cartridge you wish to replace.



**NOTE:** Before removing the cartridge, the appropriate print jet must heat up to its target temperature. Melted material may extrude into the jet wiper.



**NOTE:** Under the current temperature reading, the display will indicate when the printer is priming. Once it has been primed, another message will appear that indicates that the motor that feeds the material into the print jet is reversing to make it easier to remove the material.

Select cartridge to change

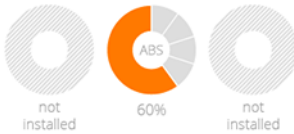

BACK

4. Reach around the material cartridge, grasp the exposed material coming from the cartridge and gently pull it out of the print jet. Select the **checkmark** to continue.

Gently pull filament out of the tube

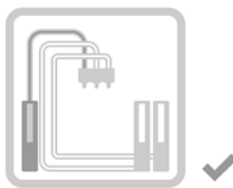

**NOTE:** For printers that have three cartridge bays, the second cartridge bay is equipped with hinges so the cartridge can rotate counter-clockwise. This provides easier access to the third cartridge.

Gently pull filament out of the tube

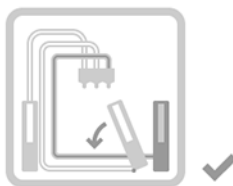

5. Grasp the cartridge handle and pull the cartridge up and out from its mount. Pull out the remaining material from the feed tube. Select the

checkmark to continue.

Pull out filament and remove cartridge

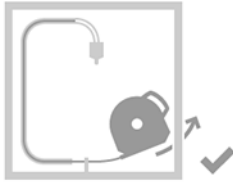

6. Install the thumbscrew into the cartridge. Measure 1 inch of material coming from the cartridge and cut off the remaining material. Select the checkmark to continue.



**CAUTION:** Do not attempt to push the excess material back into the cartridge. Doing so will cause the cartridge to bind making it unusable.

Put thumbscrew in cartridge

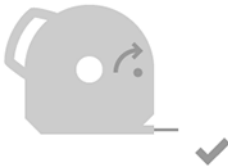

7. Remove the thumbscrew securing the material to the new material cartridge. Select the checkmark to continue.

Unpack your new cartridge



CANCEL

8. Pull out 12"/30 cm of material from the cartridge. Select the checkmark to continue.

Pull out filament from cartridge



9. Cut off 2"/5 cm of material from the end. Select the checkmark to continue.



**NOTE:** Ensure the material is not bent or creased. If the material is not straight, pull out the damaged material from the cartridge. Cut off and dispose the portion that is damaged.

Cut off end of filament



10. Insert the material under the clamp roller and into the material tube. Select the checkmark to continue.

Insert filament under clamp, through tube

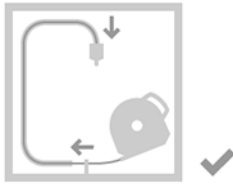

11. Gently push the material into the print jet until molten plastic extrudes into the jet wiper. Select the [checkmark](#) to continue.



**NOTE:** When the material reaches far enough into the print jet area, a feed motor will assist with feeding the material into the print jet.

Gently push filament in, until it jets out

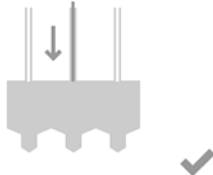

12. (1) Push the front of the cartridge into place and then (2) push the cartridge handle downward until the cartridge is fully seated in its mount. Select the [checkmark](#) to continue.



**NOTE:** Ensure the front of the cartridge (A) where the material exits is seated under the clamp roller and between the vertical alignment pins in the cartridge bay.

Push cartridge in place

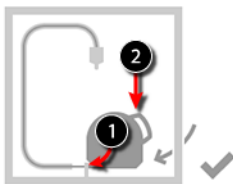

**CAUTION:** If replacing the third cartridge, be sure to rotate the second bay cartridge to its vertical position before selecting the checkmark.

Rotate cartridge back to vertical position

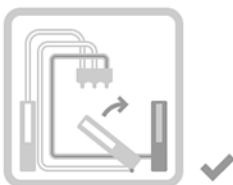

## Installing An Air Tight Material Cartridge

Before the printer will print a creation, the correct type of cartridge(s) must be installed in the printer. If the printer recognizes that no cartridge has been installed, the display will prompt you to install the appropriate cartridge.

1. Select [CHANGE CARTRIDGE](#) from the SETUP menu.

Materials



2. Select the cartridge to be installed.

Select cartridge to change

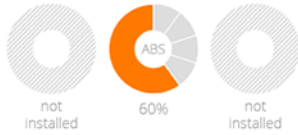

BACK



NOTE: The print jet will begin to heat.

Heating up print jet



3. Open the packaging and remove the transit plug from the new cartridge. Select the [checkmark](#) to continue.



Remove thumbscrew from new cartridge



CANCEL



4. Remove the label securing the material cap to the side of the cartridge.

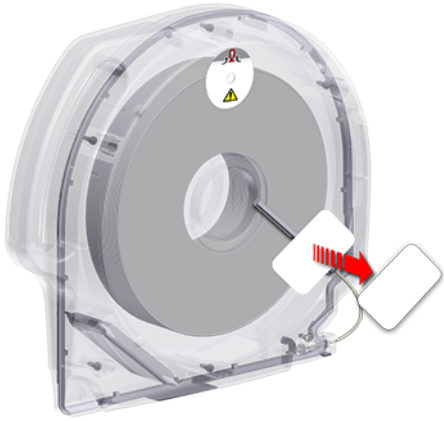

5. Carefully pull the cap off of the end of the material tube.



6. Slide the eyelet seal backwards behind the set line on the tube.

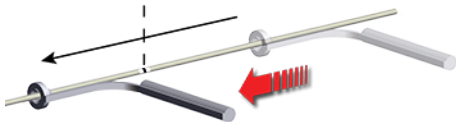

7. Pull out 12"/30 cm of material from the cartridge. Select the [checkmark](#) to continue.

Pull out filament from cartridge



8. Cut off 2"/5 cm of material from the end. Select the [checkmark](#) to continue.



**NOTE:** Ensure the material is not bent or creased. If the material is not straight, pull out the damaged material from the cartridge. Cut off and dispose the portion that is not straight.

Cut off end of filament



9. Insert the material under the clamp roller and into the material tube. Select the [checkmark](#) to continue.

Insert filament under clamp, through tube

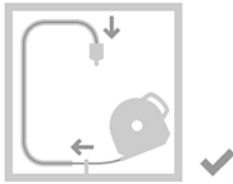

10. Gently feed the print material into the print jet until print material extrudes into the jet wiper. Select the [checkmark](#) to continue.



**NOTE:** When the material reaches far enough into the print jet area, a motor will assist with feeding the material into the print jet.

Gently push filament in, until it jets out

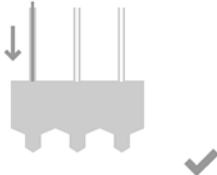

11. (1) Push the front of the cartridge into place. (2) Then, push the cartridge handle downward until the cartridge is fully seated in its mount. Select the [checkmark](#) to continue.



**NOTE:** Ensure the front of the cartridge (A) where the material exits is seated under the clamp roller and between the vertical alignment pins in the cartridge bay.

Push cartridge in place

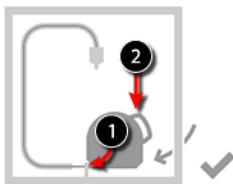

**CAUTION:** If replacing the third cartridge, be sure to rotate the second bay cartridge to its vertical position before selecting the checkmark.

Rotate cartridge back to vertical position

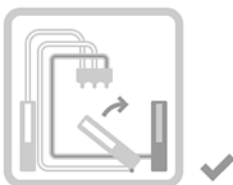

**NOTE:** The print pad must be calibrated before printing your first creation. For more information, refer to the following section titled [Calibrating The Print Pad](#).

12. Slide the eyelet seal over the tube and insert the tip into the eyelet to seal it from moisture.



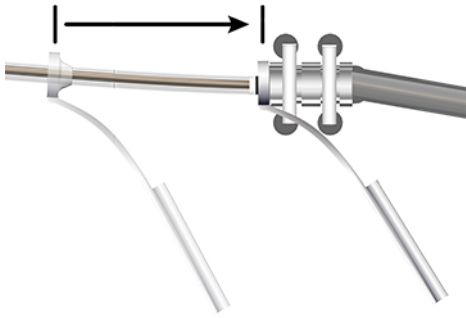

## Replacing an Advanced Material Cartridge

Replacing an advanced material cartridge is not the same procedure as replacing standard material cartridges. The formulation that enables advanced materials to print also makes the filament more fragile than ABS or PLA.

1. Select [CHANGE CARTRIDGE](#) from the SETUP menu.

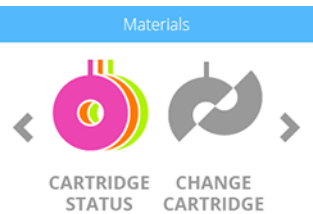

2. Select the cartridge to be installed.

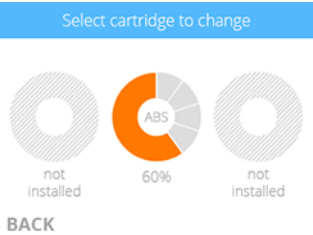

**NOTE:** The print jet will begin to heat.



3. Gently pull the print jet 2 feed tube from the extruder block and select the [checkmark](#) to continue.

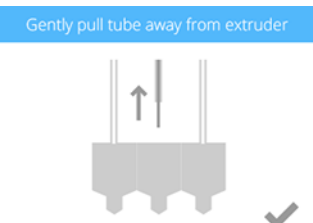

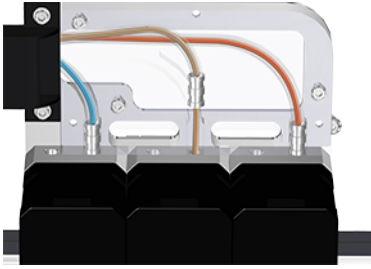

NOTE: The print material will begin to back out of the extruder.

Please wait for filament reversal

Please wait for filament reversal to complete

- Once the print material has been extracted from the extruder, cut off the end of the print material. Select the [checkmark](#) to continue.

Cut off the end of the filament

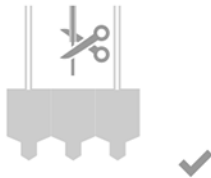

- Remove the cartridge from the printer. Select the [checkmark](#) to continue.

Pull out filament and remove cartridge

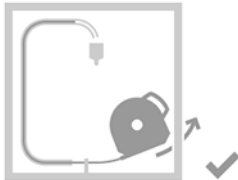

- Insert the cleaning filament into the extruder. Select the [checkmark](#) to continue.



NOTE: The metal clamp stops the end of the material from continuing into the extruder. You should not reach this point while cleaning the extruder.

Insert cleaning filament into extruder

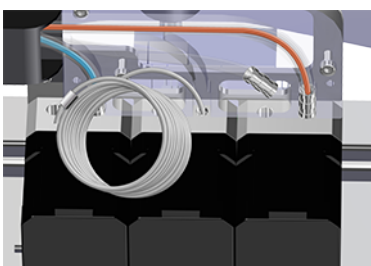
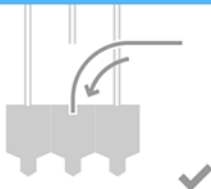

7. When prompted, pull out the cleaning filament from the extruder. Select the [checkmark](#) to continue.

Pull the cleaning filament out

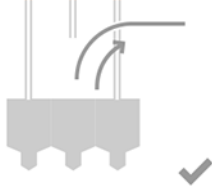

8. Open the packaging and remove the transit plug from the upper right side of the new cartridge. Select the [checkmark](#) to continue.

Unpack your new cartridge



9. Pull out 12"/30 cm of material from the cartridge. Select the [checkmark](#) to continue.

Pull out filament from cartridge



10. Insert the filament under the cartridge clamp, through the eyelet and into the feed tube. Continue to feed the filament through the tube until it comes out of the eyelet near the extruder block. Select the [checkmark](#) to continue.

Insert filament under clamp through tube



11. Feed the filament until it protrudes 40 mm out of the eyelet near the extruder block. Select the [checkmark](#) to continue.

Gently feed filament to 40mm past tube

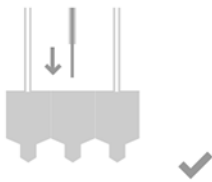

12. Push the cartridge into position in cartridge bay 2. Select the [checkmark](#) to continue.

Push cartridge in place



13. Gently insert the filament into the extruder. Select the [checkmark](#) to continue.

Insert filament into the extruder

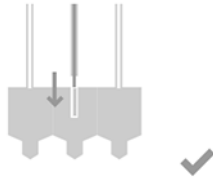

14. As the material feeds into the extruder, insert the feed tube and eyelet into the extruder block. Select the [checkmark](#) to continue.

Push the tube back into extruder

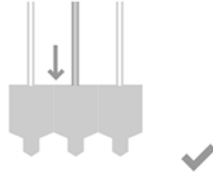

15. After some print material has been purged, the nozzle will begin to cool.

Please wait for print jets to cool down



16. Select the [checkmark](#) to complete the cartridge installation.

Cartridge installation complete!



## Setting Up An Ad Hoc Network

An ad hoc network is a temporary yet direct connection between a computer or device and the printer. It does not connect through a router or base station and the data transfer rates are slower than the transfer rate of standard wireless networks. The computer or device you wish to connect ad hoc to the printer must have an ad hoc adapter installed. An ad hoc network is deleted when the user has disconnected from it or is out of range of other devices on the network unless it has been made a permanent network.

1. Select [SETUP](#) from the home screen.

Eve, reporting for duty!



2. Using either the left or right the navigation arrows, navigate to the Network screen.
3. Select [WIFI](#).



4. Select [ADHOC](#) from the Select WIFI Connection Type screen.



5. Select the [ON/OFF](#) bar to turn on the ad hoc network connection.



6. Confirm your choice by selecting the [checkmark](#).



**NOTE:** The Select WIFI Connection Type screen will display the ad hoc status as well as the IP address of the printer.



7. In Windows®, select [Start > Control Panel](#).
8. Type [network](#) in the search box.
9. Select [Network](#) and Sharing Center.
10. Select [Set up a new connection or network](#).
11. Select [Set up a wireless ad hoc \(computer-to-computer\) network](#).
12. Select [Next](#).
13. Follow the steps in the wizard.

## Maintenance

### General Cleaning

Waste material from the printing process can accumulate inside the printer. Using a slightly damp, lint-free cloth, wipe the interior of the CubePro including the print plate, the print pad, cartridge bays and anywhere else you might find pieces of plastic waste material.



**RISK OF SHOCK: DO NOT WIPE DOWN ANY ELECTRICAL COMPONENTS. ALWAYS KEEP AWAY FROM ALL AREAS WHERE ELECTRONIC COMPONENTS ARE INSTALLED.**

### Cleaning The Jet Wiper

In addition to being a scraper for the print jets, the jet wiper assembly is also a refuse bin, collecting print material that has been primed from the print jets. As the jet wiper fills, it will need to be emptied regularly.

1. With the print pad lowered, lift the jet wiper off the thumbscrew rest.



2. Pull the jet wiper up and out to separate the mounting posts from the keyhole slots.

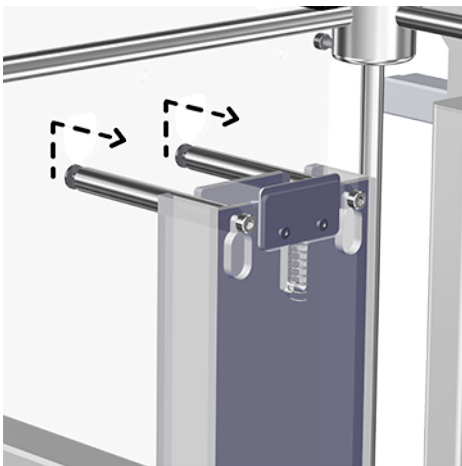

3. Remove the jet wiper assembly from the printer.
4. Remove the waste material from the jet wiper and then reinstall it in the CubePro. Refer to the section titled [Unpacking And Initial Setup](#) for more information about installing the jet wiper. Recycling information can be found in the section titled [Cubify Sustainability Program](#).

### Restoring Roughness To The Print Pad

If the print pad is too smooth, the print material and glue may not adhere properly. Using the sandpaper included in the toolkit, wipe the print pad diagonally across the print pad from corner to corner in both directions. Rinse and thoroughly dry the print pad before installing it into the printer.

### Adjusting The Jet Wiper

The jet wiper is designed to scrape the print jet tip, removing any waste material remaining after extrusion.

1. Remove the lid from the top of the printer.
2. Ensure the print pad is at its lowest position.

3. Power off the printer and disconnect it from utility power.
4. Holding the extruder assembly, gently position it over the jet wiper assembly.

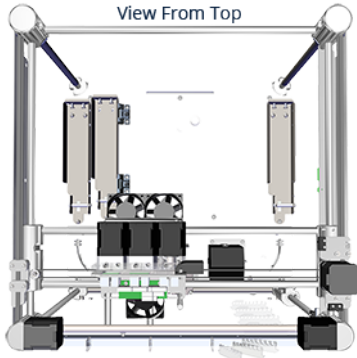

5. Verify the wiper blade meets the tapered portion (A) of the print jet tip. If it does, the jet wiper is properly adjusted. Proceed to step 8.



**NOTE:** If the wiper tip is too high, proceed to the next step. If the wiper tip is too low, proceed to step 7.

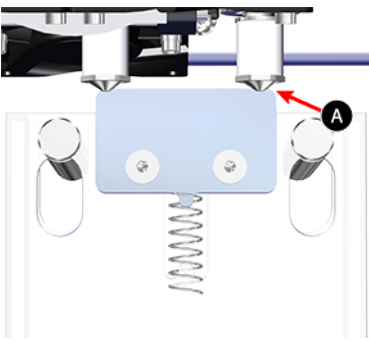

6. If the wiper blade is too high, remove the jet wiper assembly and turn the adjustment thumbscrew (A) clockwise. Reinstall the jet wiper and return to step 5.

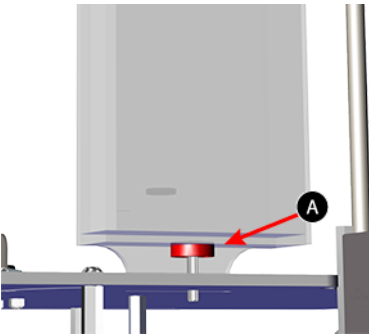

7. If the wiper tip is too low, remove the jet wiper assembly and turn the adjustment thumbscrew (A) counter-clockwise. Reinstall the jet wiper and return to step 5.

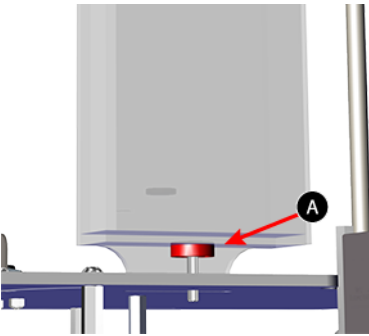

8. Once satisfied with the adjustment, you may connect your printer to utility power and power on the printer.

## Calibrating The Print Pad

The print pad is leveled at the factory and this adjustment may not be necessary for your printer. If your creations are not printing as expected, check the level of the print pad.

1. Navigate to the Print Plate Calibration screen and select **LEVEL PLATE**. Select the **checkmark** to continue.



**NOTE:** The print pad will raise and the print jets will move to the left rear of the print pad.

Print plate calibration



2. Select the upper right corner of the triangle on the touchscreen display.



**NOTE:** The print jets will move to the right rear of the print pad.

Level plate



3. Using the designated page from the Setup/Repack instructions, slide the paper between the print jets and the print pad.



**NOTE:** If there is a slight resistance, proceed to step 5.



**NOTE:** The red line (C) illustrates the gap between the print jets (A) and the print pad (B).

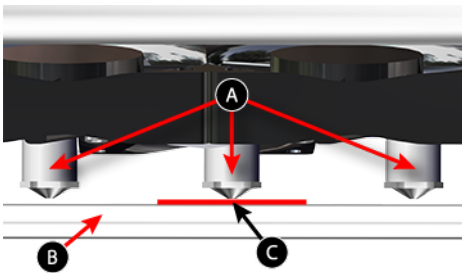

4. If the paper slides easily between the print jets and print pad, rotate the adjustment knob counter-clockwise (from the bottom) until there is a slight resistance.



**CAUTION:** If the print pad is set too high, damage to the print pad or print jets may occur.



**NOTE:** If the paper can not be inserted between the print jets and the print pad, turn the adjustment knob clockwise (from the bottom) until there is a slight resistance on the paper.

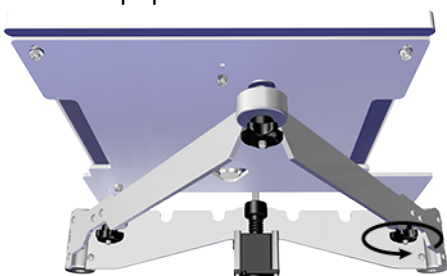



5. Select the lower middle triangle.

Level plate



6. Once the print jets have moved to the front center of the print pad, slide the paper between the print jets and the print pad.



NOTE: If there is a slight resistance, proceed to step 8.

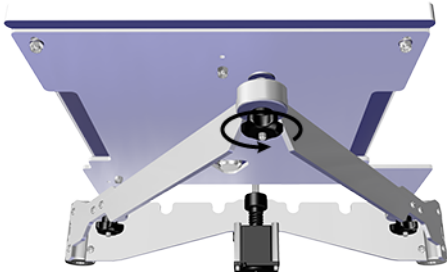

7. If there is no resistance on the paper when sliding it between the print jets and the print pad, rotate the adjustment knob counter-clockwise (from the bottom) until there is a slight resistance.



**CAUTION:** If the print pad is set too high, damage to the print pad or print jets may occur.



NOTE: If the paper can not be inserted between the print jets and the print pad, turn the adjustment knob clockwise (from the bottom) until there is a slight resistance on the paper.

8. Select the upper left corner of the triangle.

Level plate



9. Once the print jets have moved to the left rear of the print pad, slide the paper between the print jets and the print pad.



NOTE: If there is a slight resistance, proceed to step 11.

10. If there is no resistance on the paper when sliding it between the print jets and the print pad, rotate the adjustment knob counter-clockwise (from the bottom) until there is a slight resistance.



**CAUTION:** If the print pad is set too high, damage to the print pad or print jets may occur.



NOTE: If the paper can not be inserted between the print jets and the print pad, turn the adjustment knob clockwise (from the bottom) until there is a slight resistance on the paper.

11. Once completed, select the checkmark to exit the utility.

Level plate



## Calibrating The Z-Gap And Print Pad Level

Leveling the print jet nozzles is very important to ensure quality prints especially after replacing a print jet, an extruder assembly or the print pad.

The Print Jet Level Gap calibration files require cartridges to be installed in each cartridge bay.



**NOTE:** Ensure the file used matches the material type installed in cartridge bay 1. (Ex. If cartridge bay 1 has an PLA material cartridge, print the PLA Level Gap file. If cartridge bay 1 has PLA and cartridge bay 2 has INF, select the appropriate filename that matches the materials you have installed.)

These files are available at [www.3dsystems.com/shop/cubepro/downloads](http://www.3dsystems.com/shop/cubepro/downloads). You can download the files here:

### Calibration Files

#### Level Gap Calibration Print Overview

The following diagram illustrates a leveled print pad with a proper Z-Gap:

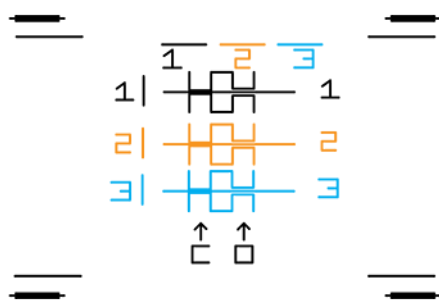

**Z-Gap** - The Z-Gap is the distance between the print pad and the print jet nozzles.



**Print Pad Level** - The Print Pad Level is a measurement to determine if the print pad is level with the print jet nozzles.

#### Printing the Level Gap Calibration File



**NOTE:** Ensure the print pad is completely clean from glue and printed parts before beginning this procedure.

1. Download the [CALIBRATION FILES](#) and extract them to your computer's hard drive.
2. Navigate to the file location and copy the appropriate file to your USB mass storage device.
3. Insert the USB mass storage device into the USB host port on the printer.
4. Select **PRINT**.

Eve, reporting for duty!



PRINT



SETUP

5. Using the arrows, navigate to the Level Gap Calibration file and select **PRINT**.



**NOTE:** There are two Level Gap Calibration files as well as four Nozzle Offset Calibration files. The two Level Gap Calibration files are print material specific. Select the file based on the material cartridge type installed in cartridge bay 1.

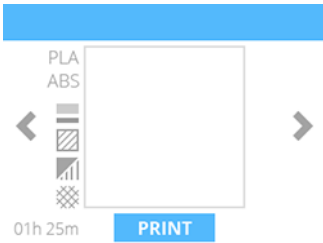

6. Apply two thin layers of Cube Glue to the print pad in an area of 50 mm x 50 mm. Select the [checkmark](#) to continue.



NOTE: For more information, refer to the section titled [Applying Cube Glue](#).



NOTE: It may take several minutes to print the file.

7. When finished, remove the print pad and verify the Level Gap.



NOTE: Refer to the sections titled [Reading The Z-Gap Calibration Print](#) and [Reading The Print Pad Level Calibration Print](#).



NOTE: If any adjustments are needed, perform this procedure again after making the adjustments. Make sure all glue and plastic residues have been removed prior to performing this procedure again.

### Adjustment Knob Measurement

Adjusting the level plate adjustment knob should initially be performed in 1-step increments. If a finer adjustment becomes necessary, adjust the knobs in 1/2 step increments.

In the following illustration, the measurement between 1 and 2 is considered 1-step.

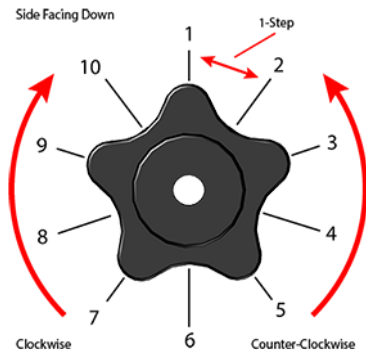

### Adjusting the Z-Gap

The Z-Gap should be within specifications before adjusting the Level Gap. If adjustments to the Z-Gap are necessary, perform the adjustments and then print the calibration file again to verify the correct Z-Gap. A correct Z-Gap is indicated when there is no gap in the Closed Z-Gap measurement and there is a gap in the Open Z-Gap measurement.



NOTE: The Closed Z-Gap (A) and the Open Z-Gap (B) are two different measurements but should be read together.

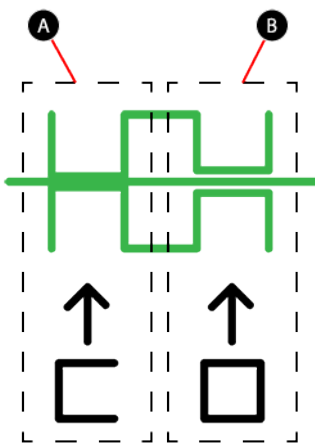

**Correct Closed Z-Gap**

Referring to the illustration, the Closed Z-Gap bars (B) should touch the baseline (A).

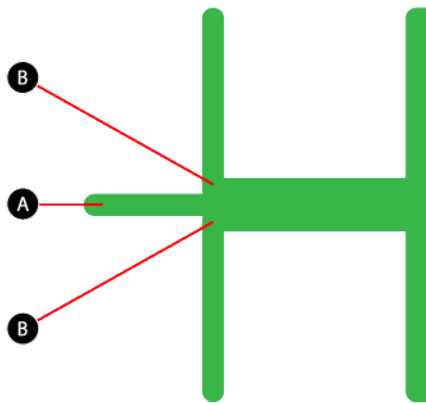

### Incorrect Closed Z-Gap

If there is a gap (B) between the Closed Z-Gap bars and the baseline (A), turn all three print pad adjustment knobs counter-clockwise (left) 1-step and then print the file again to verify the lines touch. If the lines do not touch on the second print, adjust the knobs again 1-step and reprint the file. Continue to do this until the lines meet.

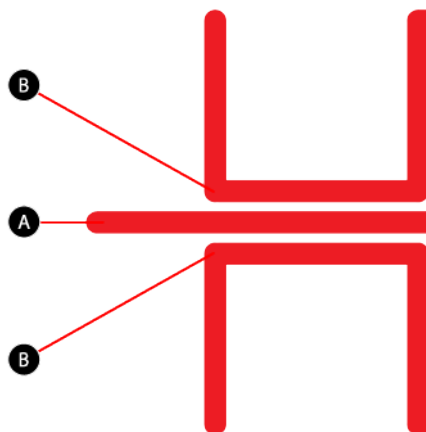

### Correct Open Z-Gap

If there is a gap (B) between the Open Z-Gap bars (C) and the baseline (A) and there is no gap between the Closed Z-Gap bars and the baseline, the Z-Gap is correct.

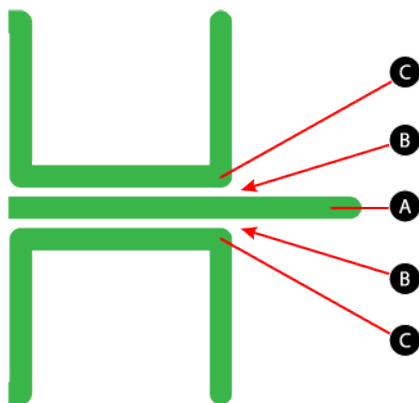

### Incorrect Open Z-Gap

If there is no gap (B) between the Open Z-Gap bars (C) and the baseline (A), turn all three (3) print pad adjustment knobs clockwise (right) 1-step and print the file again to verify that the lines do not touch. If they touch on the second print, adjust all three (3) print pad adjustment knobs clockwise (right) 1-step and reprint the file. Continue this procedure until there is a gap.

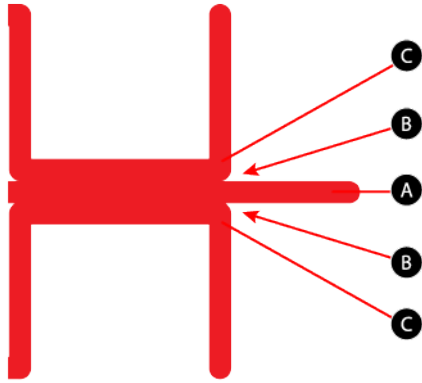

Reading the Print Pad Level Calibration Print

### Correct Print Pad Level

The Print Pad Level is correct when each of the four (4) corner calibration points have no gaps between the Print Pad Level calibration lines and the baselines.



NOTE: Before making any adjustments to the Print Pad Level, the Z-Gap must be correct.

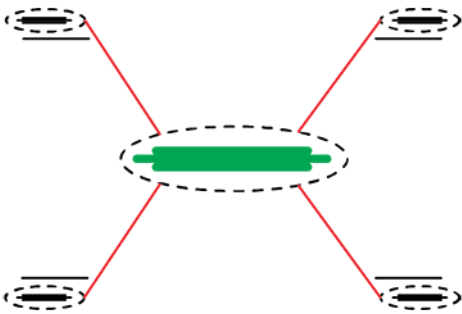

### Incorrect Print Pad Level

In the illustration, there is an incorrect gap between the Print Pad Level calibration lines and the baselines on the front of the print pad and no gap between the Print Pad Level calibration lines and the baselines on the back of the print pad. The front of the print pad needs to be raised. To correct the Print Pad Level in this instance, turn the front print pad adjuster knob counter-clockwise (left) 1-step. Reprint the file and verify that all four corner calibration points are correct.

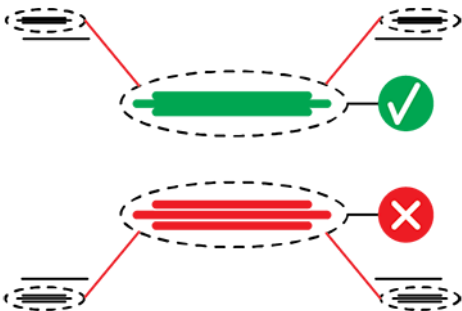

### Acceptable Print Pattern

The Print Pad Level calibration file should print with no gap between the Print Pad Level calibration lines and the baselines. The illustration indicates an acceptable print pattern from a profile view.



### Unacceptable Print Patterns

If the gap between the print pad and the print jet nozzles is too small, the Print Pad Level calibration lines will press in and scrape the baseline. If all four corner calibration points appear like the pressed profile illustration (A), turn the three (3) print pad adjuster knobs clockwise (right) 1-step to increase the gap. Reprint the Print Pad Level calibration print again.

If there is a gap between the Print Pad Level calibration lines and the baselines like the illustration (B), turn the three (3) print pad adjuster knobs counter-clockwise (left) 1-step to decrease the gap. Reprint the Level Gap calibration print.

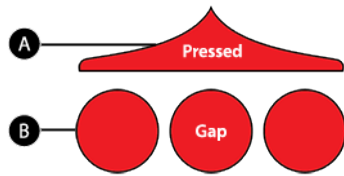

NOTE: Once all four corner Print Pad Level calibration points are correct, verify the Z-Gap to ensure that it is still correct.

### Calibrating The Offset Jets



**WARNING: DO NOT USE THE OFFSET JETS MENU UNLESS YOU HAVE BEEN ADVISED TO DO SO BY CUBIFY SUPPORT. CHANGES TO THESE SETTINGS WILL AFFECT THE QUALITY OF MULTI-COLOR OR MULTI-MATERIAL PRINTS. CALIBRATION WAS PERFORMED BY THE FACTORY AND ANY CHANGES TO THESE SETTINGS MUST BE APPROVED AND GUIDED BY CUBIFY SUPPORT.**



NOTE: Calibrating the Offset Jets is only applicable for printers with more than one (1) print jet installed.

Calibration files can be downloaded from [www.3dsystems.com/shop/cubepro/downloads](http://www.3dsystems.com/shop/cubepro/downloads). These files are printed like any other .cubepro file. There are four files available. The files are specific for the model printer (CubePro Duo or CubePro Trio) and for the material type (ABS or PLA) currently installed in the printer. All installed cartridges must be same material type (ABS or PLA) and each print jet will be used. Two Level Gap calibration files will also download with the Offset Jet Calibration files. These should be ignored during this procedure.

### Calibration Overview

Depending on your printer model, you may have up to three (3) print jets installed. Calibrating the offset jets becomes necessary when multi-color or multi-material prints are not aligned properly. If the print jets are not positioned properly, supports may not print as intended and print geometries may be altered.

When it becomes necessary to calibrate the offset jets, each print jet will be tested for proper alignment. When printing the test file, a scale will be printed by all print jets and the scales printed by print jets 2 and 3 will be compared to the scale printed by print jet 1.



NOTE: It is very important to compare the scales printed by print jet 2 and print jet 3 to the scale printed by print jet 1. Print jet one should not be adjusted.

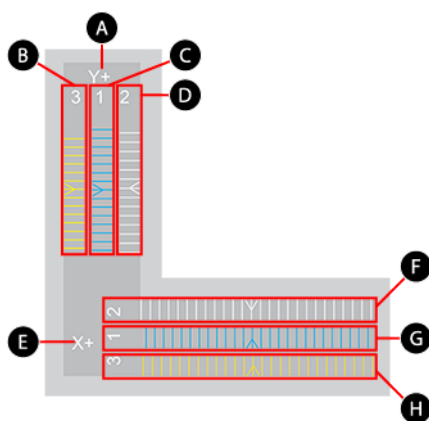

**A** Y-Axis Scale

**E** X-Axis Scale

**B** Print Jet 3 Y-Axis Scale

**F** Print Jet 2 X-Axis Scale

**C** Print Jet 1 Y-Axis Scale

**G** Print Jet 1 X-Axis Scale



Print Jet 2 Y-Axis Scale



Print Jet 3 X-Axis Scale

In the print scale illustration, the X+ scale (left-to-right) contains three (3) rows of printed lines. Each line represents a print jet. The prints are numbered 1, 2 and 3 for each of the three print jets. Print jet 1 always prints the middle scale so the scales of print jets 2 and 3 can be easily compared to it. Print jet 2 prints above print jet 1 and print jet 3 prints below print jet 1. For printers with only two (2) print jets, the scale below the print jet 1 scale will not be printed.

The lines on the calibration print represent an offset of 0.1 mm and should be measured from the printed arrows in the center of the scales.

### Reading the Offset Jets Scale

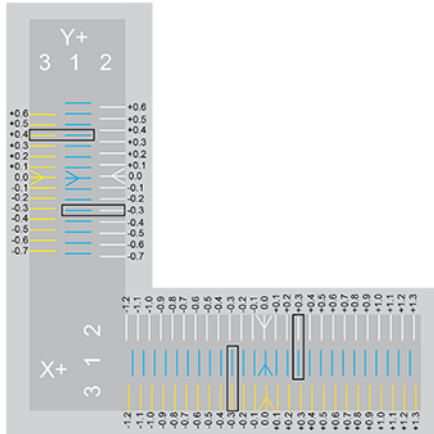

Note the white arrow printed from print jet 2 and compare it to the positioning of the blue arrow printed by print jet 1. Note that the white arrow is slightly left of the blue arrow meaning that print jet 2 is misaligned. Print jet 2 must be moved in a positive direction (right) to align with print jet 1.

Compare the printed lines of print jet 1 and 2 to the right of the arrows and find the printed lines that are properly aligned. In this illustration, the lines at +0.3 are aligned. This means that the offset must be corrected by increasing the offset by .3 mm.

When comparing the arrow printed by print jet 3 to the arrow printed by print jet 1, notice it is positioned slightly to the right. This means it must be adjusted in a negative (left) direction. Compare the lines of print jet 1 and 3 to the left of the center arrows and find the printed lines that are properly aligned. In this illustration, the lines at -0.3 are aligned. This means that the offset must be corrected by decreasing the offset by .3 mm.

### Offset Jets Calibration Procedure

The following procedure demonstrates calibrating print jets 1 and 2 on the X-axis. Calibrating the Y-axis is the same procedure. The illustration below will be used for demonstration purposes. Be sure to refer to the actual scale printed by your printer and adjust the settings accordingly.

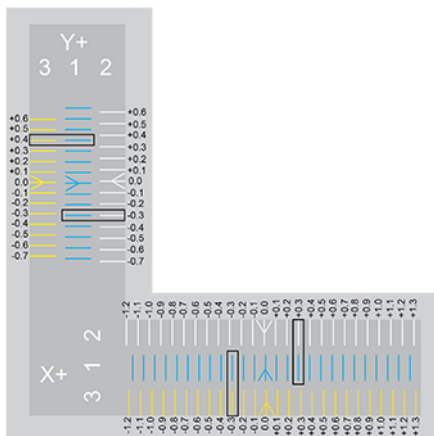

1. Download the [CALIBRATION FILES](#).
2. Extract the files to your computer's hard drive.
3. Navigate to the file location and copy the appropriate Nozzle Offset Calibration file to your USB mass storage device.



**NOTE:** The Nozzle Offset Calibration files are specific for the model printer (CubePro Duo or CubePro Trio) and for the material type (ABS or PLA) currently installed in the printer.

4. Insert the mass storage device into the CubePro USB inlet port and select **PRINT**.

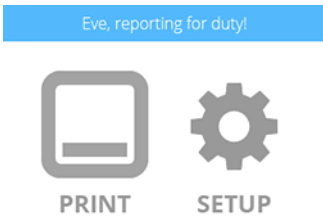

5. Navigate to the calibration file and select **PRINT**.



**NOTE:** The printer may require you to install additional cartridges or replace a cartridge. Follow the instructions on the screen and refer to the section titled [Replacing A Material Cartridge](#).



6. Once the printer has finished printing, remove the print pad from the printer and inspect the scales. If adjustments are required, proceed to the next step. If the scales are aligned properly, no further action is required.
7. Navigate to the Print Jet Calibration screen and select **OFFSET JETS**.



8. When adjusting print jet 2, select **B**.

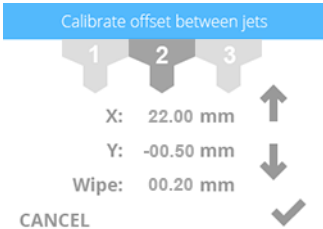

9. Referring to the illustration at the beginning of this procedure, print jet 2 needs to be increased by .3 mm. Select the value until the first digit (A) to the right of the decimal point is highlighted.

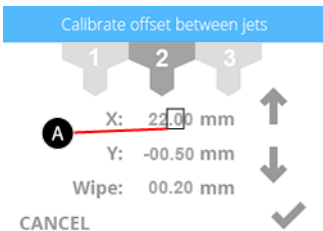

10. Press the up arrow three times to increase the value to 22.30 mm.



**NOTE:** Pressing the up arrow increases (+) the value. Pressing the down arrow decreases (-) the value. Pressing the value repeatedly will scroll through the digits left-to-right.



**NOTE:** You can also select the Y-axis settings and adjust those settings the same way.





**NOTE:** If a value of 1 mm or larger are required, press the value until the first digit to the left of the decimal is highlighted and press the up arrow accordingly.

- Once finished adjusting the settings, select the [checkmark](#) to continue.
- Remove the original calibration print from the print pad. Reprint the calibration file and verify that the arrows align properly on the X-axis and Y-axis.

## Calibrating The Wipe Function



**WARNING: DO NOT USE THE OFFSET JETS MENU UNLESS YOU HAVE BEEN ADVISED TO DO SO BY CUBIFY SUPPORT. CHANGES TO THESE SETTINGS WILL AFFECT PRINTER OUTPUT. CALIBRATION WAS PERFORMED BY THE FACTORY AND ANY CHANGES TO THESE SETTINGS MUST BE GUIDED BY CUBIFY SUPPORT.**

As the printer extrudes print material through the print jets, print material may sometimes adhere to the print jet tips. The printer firmware moves the print jets over the jet wiper assembly blade to scrape excess print material from the print jets. If the setting for the Wipe function is not properly set, the print jets may not reach the jet wiper assembly blade and the hardened excess print material may be released into the next print.

The factory settings position the print jets about .25"/6.35 mm in front of the jet wiper assembly blade.

- Browse to the Print Jet Calibration screen and select [OFFSET JETS](#).



- Press the Wipe value repeatedly to scroll through the digits. Press the up arrow to move the print jets forward and the down arrow to move the print jets backward.



**NOTE:** Increasing the value moves the print jets toward the front of the printer. Decreasing the value moves the print jets toward the back of the printer.



- Select the [checkmark](#) to continue.
- Print a small test file and verify the print jets move over the jet wiper assembly blade after extruding print material.

## Testing The Print Jets And Extruders

When material fails to come out of the print jets during a print, you may receive a warning message on the display. The **CONTROL JETS** function from the Print Jet Calibration menu is a utility that enables you to test the print jet heating elements and the extruder operation.

- Navigate to the Print Jet Calibration screen and select [CONTROL JETS](#).



2. Select the print jet you wish to test.



3. Select the target temperature value twice to read 260°C.



NOTE: To increase or decrease the temperature value, press the up or down arrow.



NOTE: The typical printing temperature for ABS print material is 260°C. The typical printing temperature for PLA material is 220°C. For best results, leave the default target temperature at 260°C while extruding print material from the Control Jets test utility.



NOTE: The current temperature reading will appear above the target temperature value.

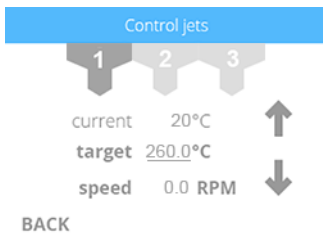

4. Once the temperature has reached 260°C, select the speed value.



NOTE: Pressing the speed value twice will place the value at 4.0 RPM. Press the up or down arrows to increase or decrease the extrusion speed.



5. Once you have finished, reduce the target speed to 0.0 RPM and the target temperature to 0.0°C. You can now select the next print jet and follow this procedure if necessary.



NOTE: Pressing the values twice for target temperature and speed should change the values to 0.0.

For further troubleshooting, contact Cubify Support at [cubifysupport@cubify.com](mailto:cubifysupport@cubify.com).

## Moving The Print Jets

The Print Plate Calibration menu provides a way to manually move the print jets and the print pad. The MOVE JETS utility can be useful to test the X, Y and Z motors to ensure they are working properly.

1. To move the print jets or the print pad, select **MOVE JETS**.

Print plate calibration



2. Move the print jets or print pad in the desired direction and select the checkmark when finished.



NOTE: The X: up arrow moves the print jets to the right and the X: down arrow moves the print jets to the left.



NOTE: The Y: up arrow moves the print jets to the back of the printer and the Y: down arrow moves the print jets to the front of the printer.



NOTE: The Z: up arrow raises the print pad and the Z: down arrow lowers the print pad.

Move print jets



## Print Jet Temperature Calibration

New print jet extruders have temperature calibration values printed on a label attached to the extruder. After replacing an extruder, the values for the new nozzle should be entered into the printer for optimum printing results.

### Procedure

1. Select **SETUP**.

Eve, reporting for duty!



2. Navigate to **CALIBRATION** and select it.

Calibration



3. Select **JET TEMP CALIBRATION**.

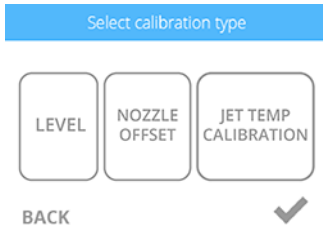

4. Select the nozzle assembly that was replaced. Select the T1 value and use the arrows to enter the appropriate T1 value found on the label adhered to the new extruder.

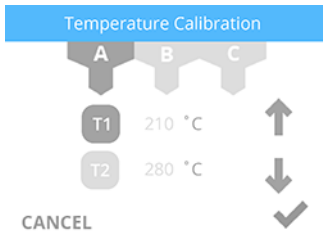

5. Select the T2 value and use the arrows to enter the appropriate value found on the label adhered to the new extruder.

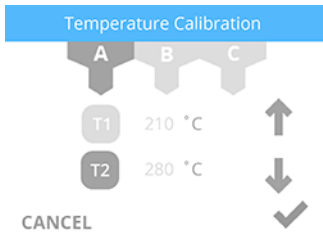

6. Select the [checkmark](#) to save the settings.

## Updating The Printer Firmware

The CubePro firmware can either be updated via wireless connection or by using a USB mass storage device. When using a USB mass storage device to update the firmware, go to [www.3DSystems.com/shop/cubepro/downloads](http://www.3DSystems.com/shop/cubepro/downloads) and download the latest firmware to your device.

### Updating Firmware Using USB

1. Select [SETUP](#).

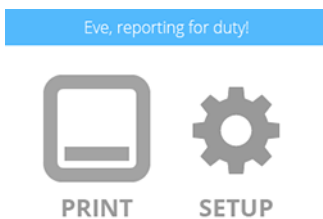

2. Navigate to the Advanced screen and select [FIRMWARE](#).

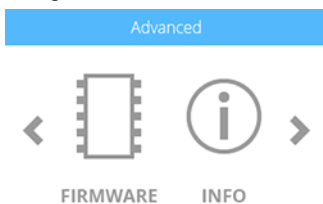

3. Select [USB KEY](#).

Select firmware update method



WIFI

BACK



USB KEY

4. Insert the USB mass storage device into the USB port and select the [checkmark](#).

Plug USB key into Cube



BACK



NOTE: The printer will search for new firmware.



NOTE: Wait until the update has been completed.



**WARNING: DO NOT POWER OFF OR DISCONNECT THE PRINTER FROM UTILITY POWER DURING THE UPDATE PROCESS.**

Installing new firmware: 66.7%



1.02

5. Press and release the touchscreen display [ON/OFF button](#) and the display will restart.

Hold button until Eve restarts



## Updating Firmware Using WI-FI

To update the firmware using the wireless utility, the printer must be connected to a wireless network.

1. Select [SETUP](#).

Eve, reporting for duty!



PRINT



SETUP

2. Navigate to the Advanced screen and select **FIRMWARE**.

Advanced



FIRMWARE



INFO



3. Select **WIFI**.

Select firmware update method



WIFI



USB KEY

BACK



NOTE: The printer will attempt to connect to the server.

Connecting to server...



NOTE: If the printer can not connect to the server, select **RETRY** to connect to the server. Select **CANCEL** if you do not want to update the firmware.

Could not connect to server



CANCEL

RETRY



NOTE: The printer will check for a firmware update.

Checking for new firmware



NOTE: The printer will begin downloading new firmware. The blue bar is also a progress indicator.



NOTE: The download could take a few minutes.



**WARNING: DO NOT POWER OFF OR DISCONNECT THE PRINTER FROM UTILITY POWER DURING THE UPDATE PROCESS.**

Downloading new firmware: 66.7%



1.02



NOTE: If no new firmware is available, select the [checkmark](#) to continue.

No new firmware available



1.01



NOTE: If the firmware download fails, select [RETRY](#) to start the download again. Select [CANCEL](#) if you do not want to update the firmware.

Firmware download failed



CANCEL

RETRY



NOTE: The firmware will begin to install. The blue bar is also a progress indicator.



NOTE: This process could take a few minutes.



**WARNING: DO NOT POWER OFF OR DISCONNECT THE PRINTER FROM UTILITY POWER DURING THE UPDATE PROCESS.**

Installing new firmware: 66.7%



4. Press and release the touchscreen display **ON/OFF button** and the display will restart.

Hold button until Eve restarts



## Replacing Fuses

The printer has two (2) fuses that are designed to provide moderate circuit protection. If the fuses become defective, refer to the following procedure to replace the fuses.



**Caution: Double Pole/Neutral Fusing.**

1. Power off the printer and disconnect the power cord from the printer.
2. Open the fuse door above the main power switch.



3. Remove the fuse cartridge from the power inlet housing.

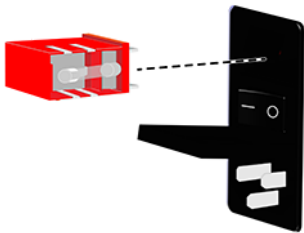

4. Remove the defective fuses and install new ones.



**Caution: Ensure the replacement fuses are rated correctly.**



**NOTE: Fuse: 5x20mm T10A L 250V.**



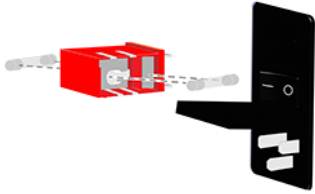

5. Insert the fuse cartridge into the power inlet housing.

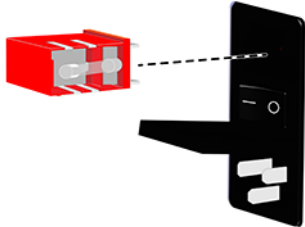

6. Close the fuse door.



7. Connect the printer power cord and power on the printer.

## Lubricating The Bearing Rods

After every 100 hours of operation, the bearing rods should be lubricated.



**Caution:** Do not spray lubricant directly on the bearing rods. Applying too much lubricant can leave residue throughout the printer. The bearings only require a thin layer of grease to operate properly.

1. Power off and disconnect the printer from utility power.
2. Apply a small amount of bearing rod grease (Part Number: 403194-00) to a clean, lint-free cloth.
3. Using the cloth, wipe the six (6) bearing rods (1-6).



**NOTE:** Ensure each bearing rod has been fully treated with a thin layer of bearing rod grease.

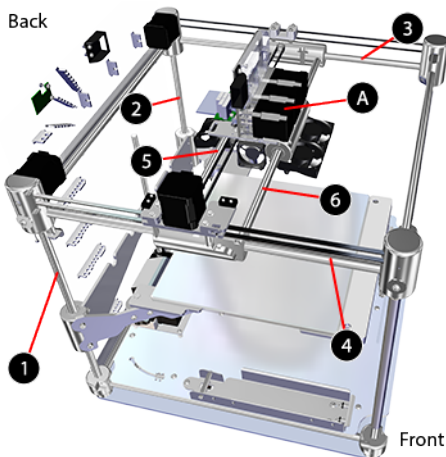

4. Manually move the print jet carriage (A - See Above) front-to-back and left-to-right.



**NOTE:** The print jet carriage should glide smoothly.

## Error Codes

### Material Flow Errors

Material flow errors that appear on the display contain two (2) digits. The first digit refers to the extruder number. (Ex. If your printer has two (2) extruders and you have code 13, the error refers to extruder 1.)

The second character refers to the error type. Refer to the following chart for descriptions of material flow error types:

Error Type	Description	Possible Cause
1	Material stopped	<ul style="list-style-type: none"><li>• Tangled cartridge</li><li>• Extruder blockage</li></ul>
2	Idler stalled	<ul style="list-style-type: none"><li>• Tangled cartridge</li><li>• Extruder blockage</li></ul>
3	Material not present	<ul style="list-style-type: none"><li>• The end of the material has been pulled into the extruder</li></ul>

### Temperature Errors

Temperature errors that appear on the display contain two (2) digits. The first digit refers to the extruder number. (Ex. If you printer has three (3) extruders and you have code 35, the error refers to extruder 3.)

The second digit refers to the error type. Refer to the following chart for descriptions of temperature error types:

Error Type	Description	Possible Cause
1	Thermistor circuit	<ul style="list-style-type: none"><li>• Possible short circuit detected</li></ul>
2	Initial rate of change low	<ul style="list-style-type: none"><li>• Contact support</li></ul>
3	High rate of temperature change detected	<ul style="list-style-type: none"><li>• A sudden change in temperature was detected</li></ul>
4	Low rate of temperature change detected	<ul style="list-style-type: none"><li>• The rate of temperature increase is below the expected rate of change</li></ul>
5	Set point deviation	<ul style="list-style-type: none"><li>• The temperature is different from the target temperature</li></ul>

For more information, contact Cubify Support.

### CONTACTING SUPPORT

Cubify Support is available at [cubifysupport@cubify.com](mailto:cubifysupport@cubify.com).

## Troubleshooting

Select the appropriate answer below to troubleshoot your printer.

### Cartridge Issues

Remove the thumbscrew when testing the cartridge.

**Question: Can the print material (filament) be easily pulled out of the cartridge?**

Yes

No

### Temperature Errors

**Question: Are the cables on each extruder PCB and the main extruder PCB fully inserted into the correct connectors?**

Yes

No

### Filament Flow Errors

**Question: Does print material (filament) pull freely from the cartridge that is installed in the cartridge bay that feeds the extruder with the error?**

Yes

No

## 3D Systems Sustainability Program

By its very nature 3D printing is a sustainable technology empowering 3D Systems' printers to produce affordable products one layer at a time using only the necessary amount of material required for each part with near zero waste in an energy efficient process.

CubePro 3D printers use eco-friendly plastics that can be recycled, re-purposed or composted responsibly. 3D Systems invites all CubePro consumers to partner in creating a cleaner world, one printed part at a time, by participating in the 3D Systems Sustainability Program.

- Cartridge Recycling: Send your empty CubePro cartridges to either our USA or Germany location. Be sure to keep the address label that comes with each cartridge for recycling.
- Plastics Recycling: Send your used PLA and ABS printed parts to either our USA or Germany location. We will properly and responsibly compost, recycle, and reuse your returned plastic parts as a renewable source to manufacture new cartridges, reducing both raw materials consumption and the waste stream.

3D Systems is committed to continuously improve the sustainability of its 3D printing products. For questions, feedback and suggestions, please contact [cubify@cubify.com](mailto:cubify@cubify.com).

Send cartridges and plastics to:

---

**3D Systems Corporation**  
333 Three D Systems Circle  
Rock Hill, SC 29730  
USA

---

**3D Systems Cartridge Recycling Centre**  
c/o UPS SCS GmbH & Co. OHG  
Biberweg 12  
53842 Troisdorf  
Germany

---

Please visit <http://3dsystems.com/shop/info/sustainability> for more information.



**WARNING: IT IS THE RESPONSIBILITY OF THE USER TO DISPOSE OF ANY REFUSE GENERATED BY THE USE OF THE CUBEPRO PRINTER IN A RESPONSIBLE MANNER ACCORDING TO ALL LOCAL LAWS AND STATUTES.**

